

Moduo

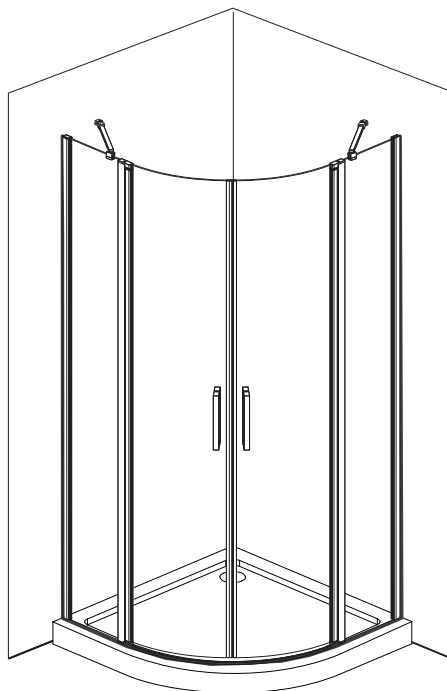

PL INSTRUKCJA MONTAŻU I EKSPLOATACJI

CZ NÁVOD NA MONTÁŽ A ÚDRŽBU

SK NÁVOD NA MONTÁŽ A ÚDRŽBU

EST PAIGALDUS- JA KASUTUSJUHEND

LT MONTAVIMO IR EKSPLOATAVIMO INSTRUKCIJA

LV MONTĀŽAS UN EKSPLUATĀCIJAS INSTRUKCIJA

DE MONTAGE- UND AUFBAUANLEITUNG

RO INSTRUCȚIUNI DE MONTAJ ȘI OPERARE

HU SZERELÉSI ÉS ÜZEMELTETÉSI ÚTMUTATÓ

UA ІНСТРУКЦІЯ З МОНТАЖУ І ЕКСПЛУАТАЦІЇ

BY ІНСТРУКЦЫЯ ПА МАНТАЖЫ І ЭКСПЛУАТАЦЫІ

RU ИНСТРУКЦИЯ ПО МОНТАЖУ И ЭКСПЛУАТАЦИИ

EN INSTRUCTIONS FOR ASSEMBLY AND USE

FR INSTALLATION ET UTILISATION - MODE

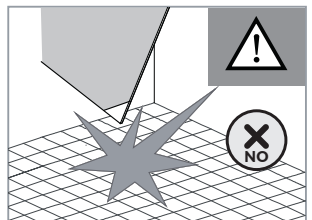
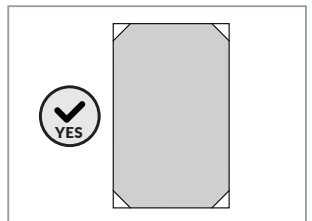
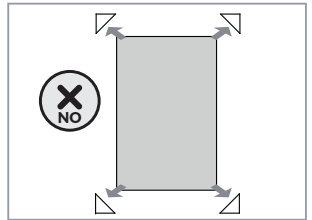
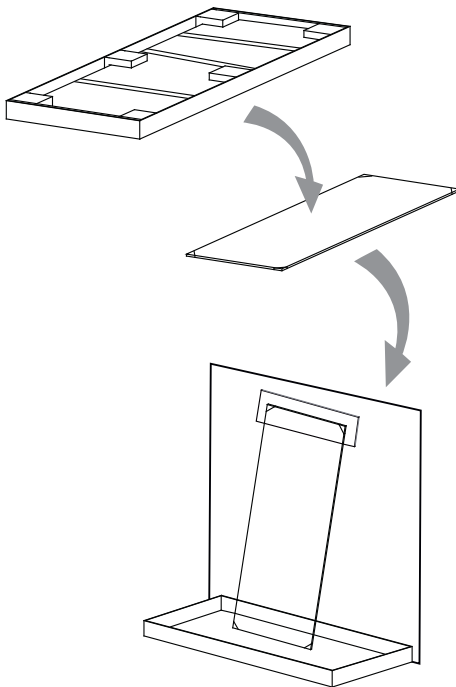
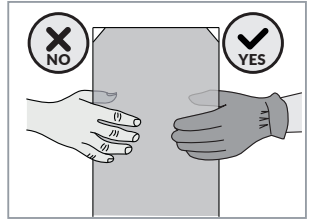
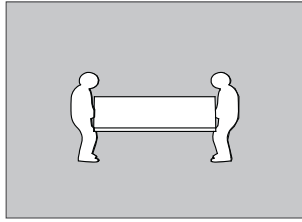
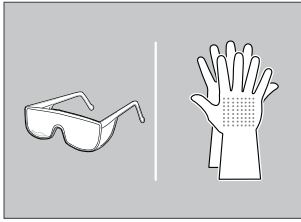
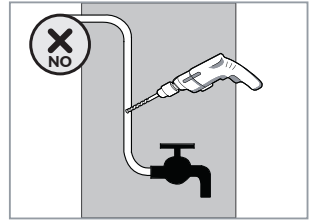
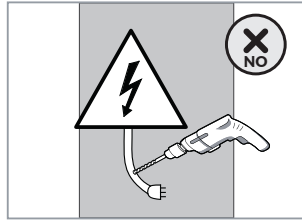
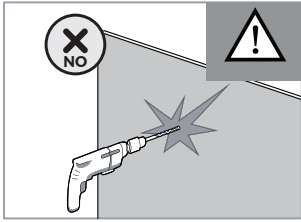

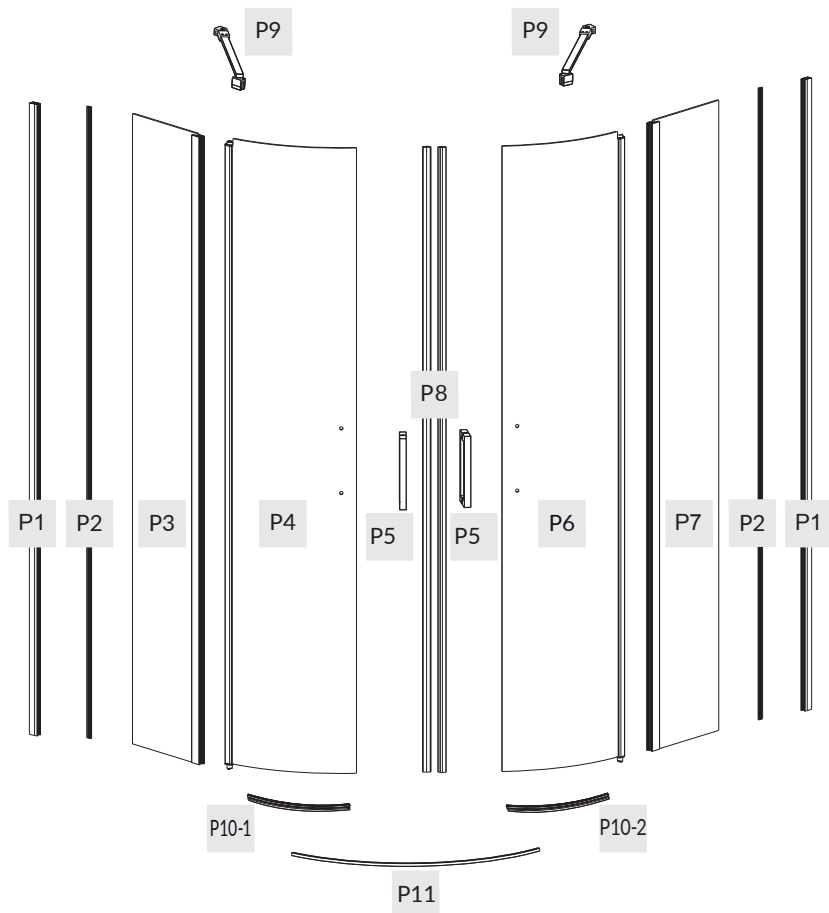
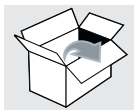

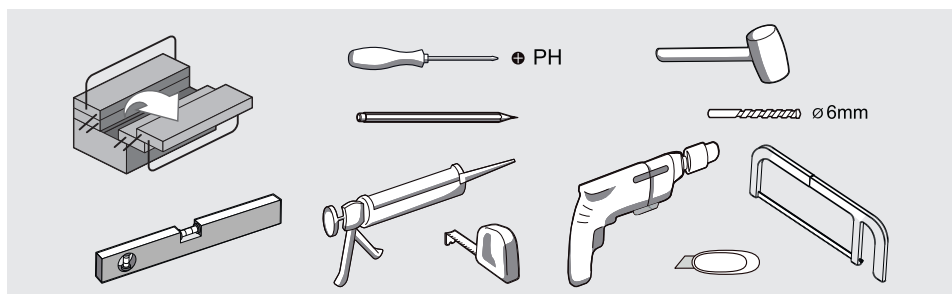
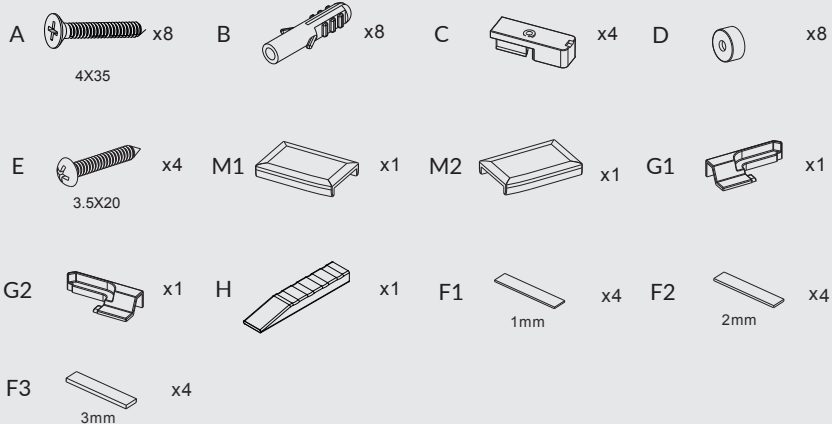
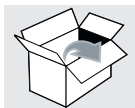

1.

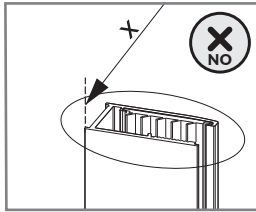
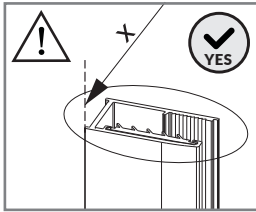

SIZE (mm)	X (mm)
800x800	790~800
900x900	890~900

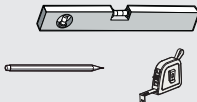
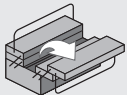
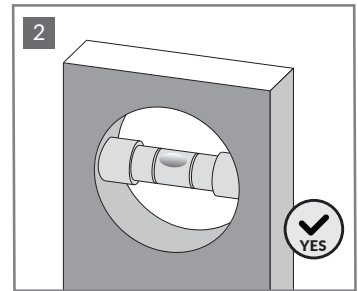
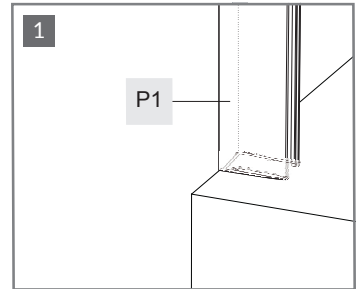
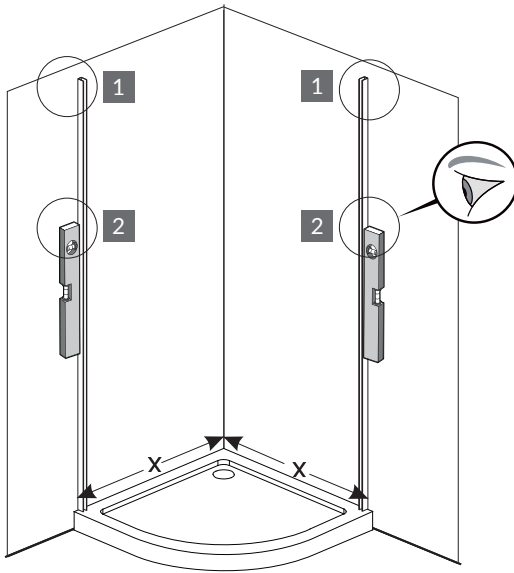

P1



x2



2.

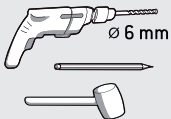
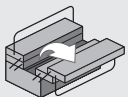
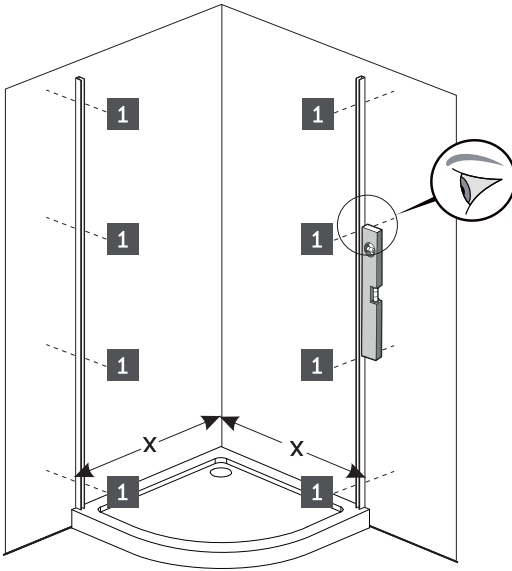
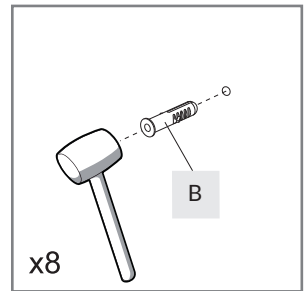
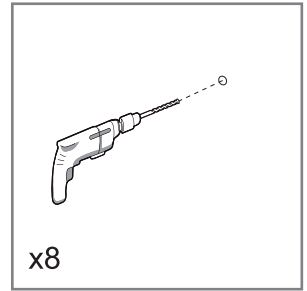
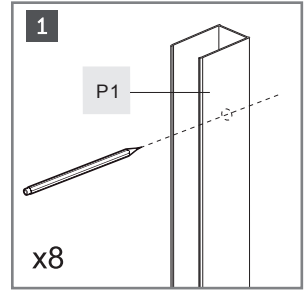
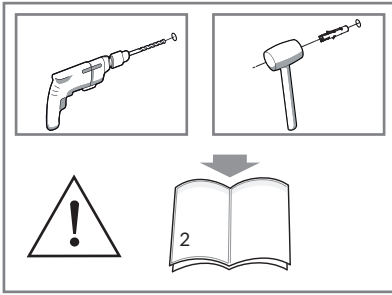

P1

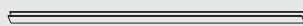

x2

B



x8



3.

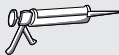
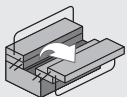
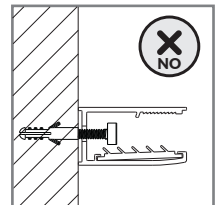
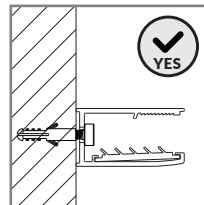
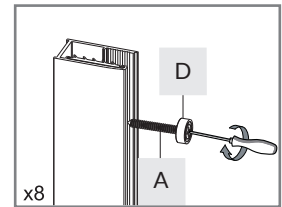
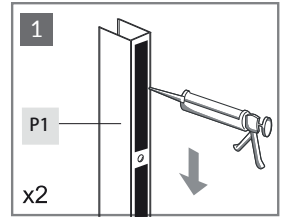
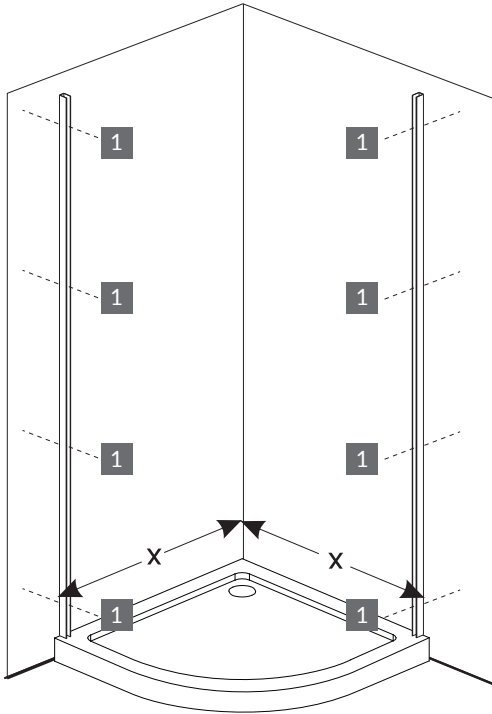

P1



x2

D



x8

A



x8



4.

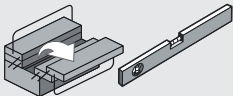
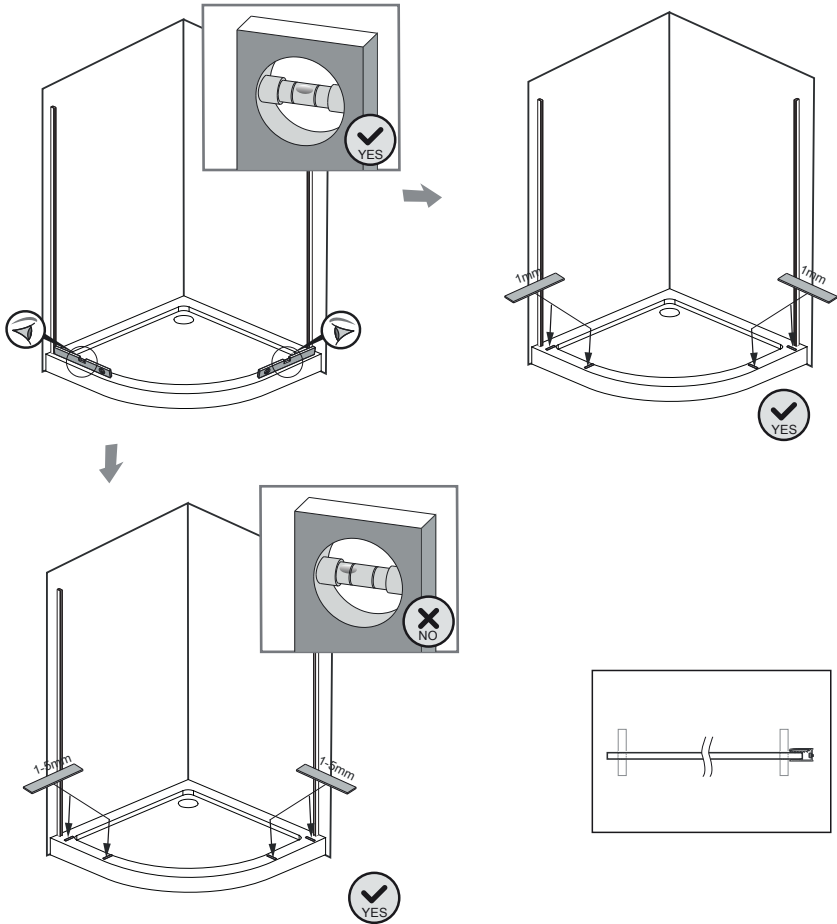

F1



x4

F2



x4

F3



x4



5.

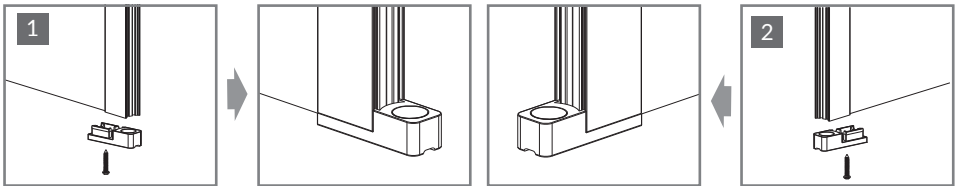
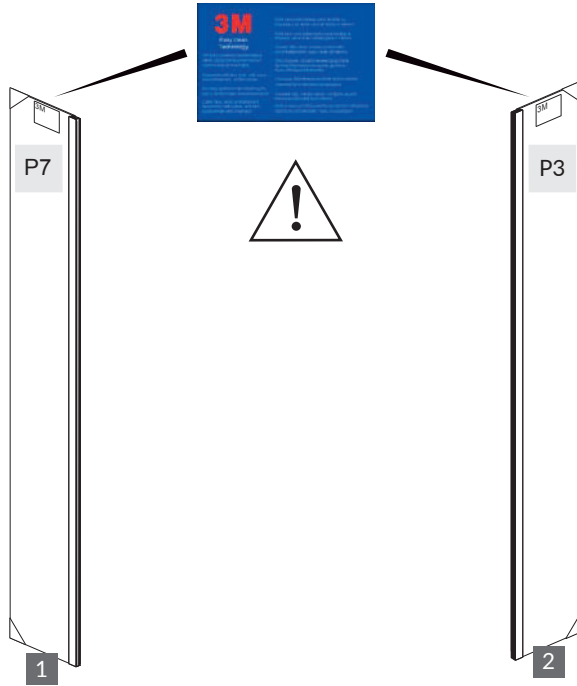

		C		x2	
		E		x2	

6.

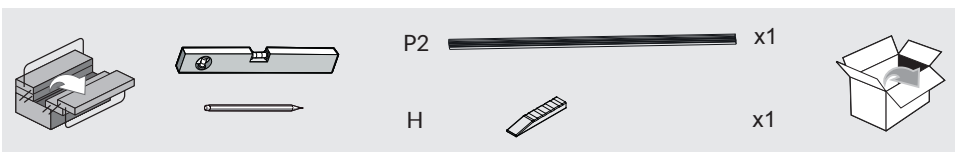
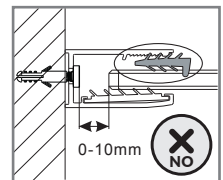
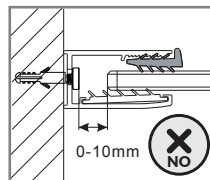
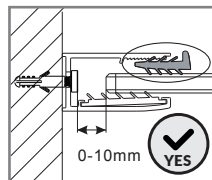
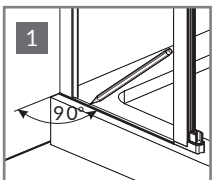
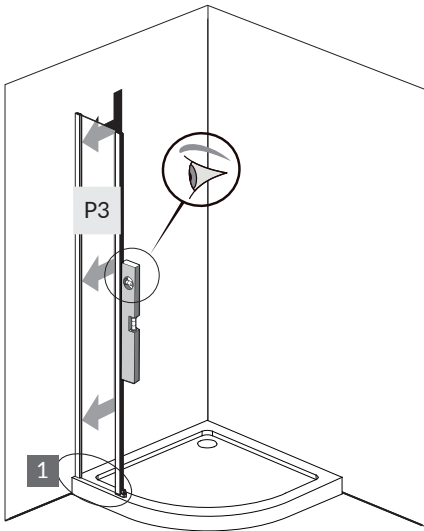
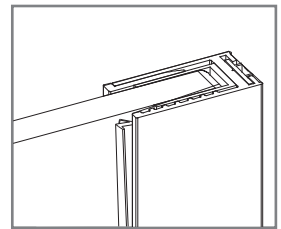
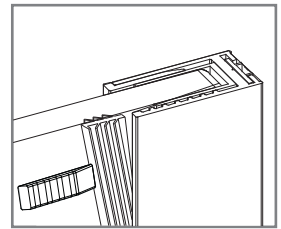
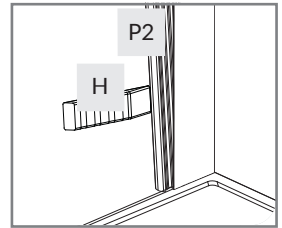
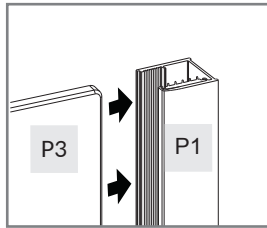
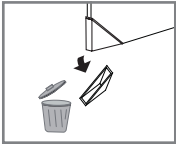
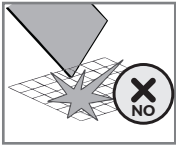

7.

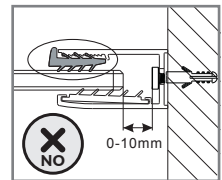
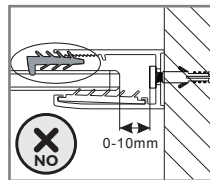
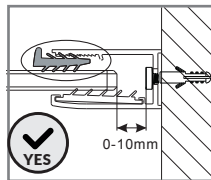
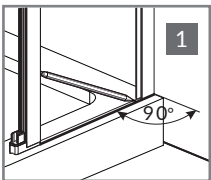
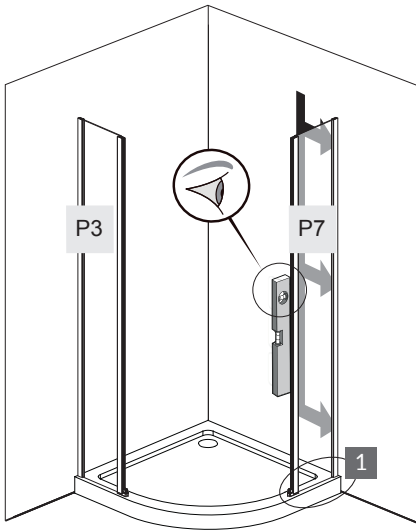
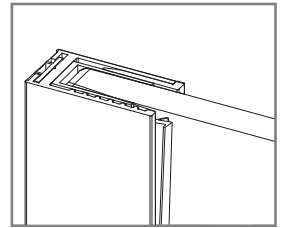
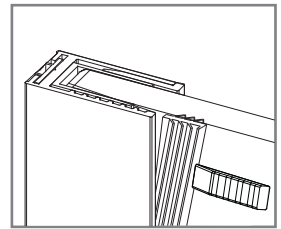
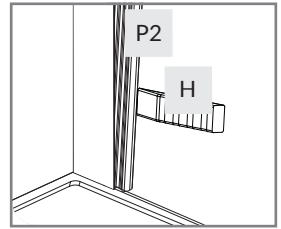
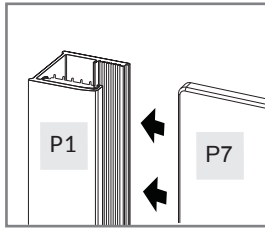
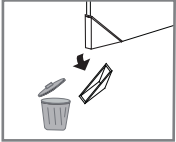
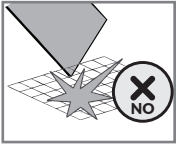

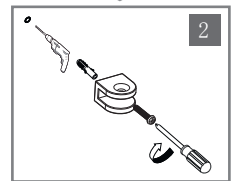
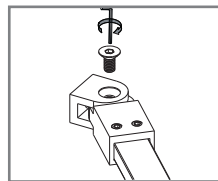
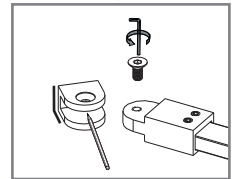
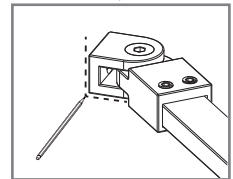
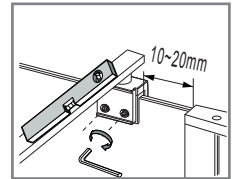
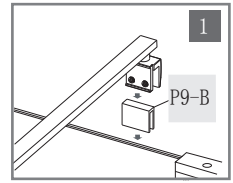
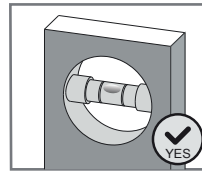
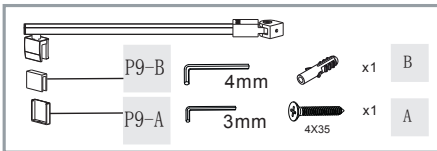
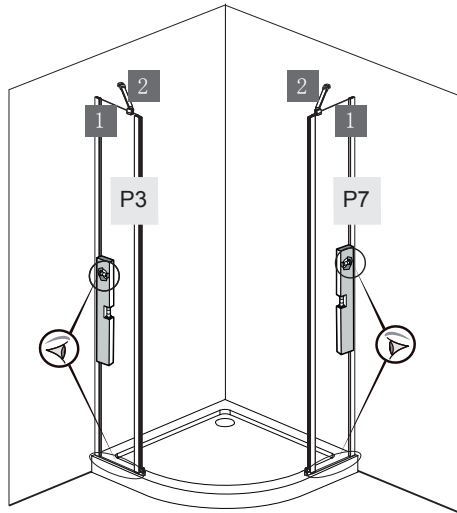
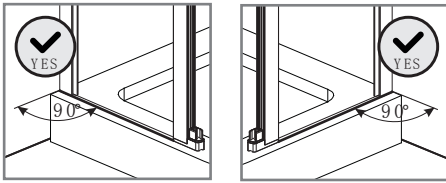

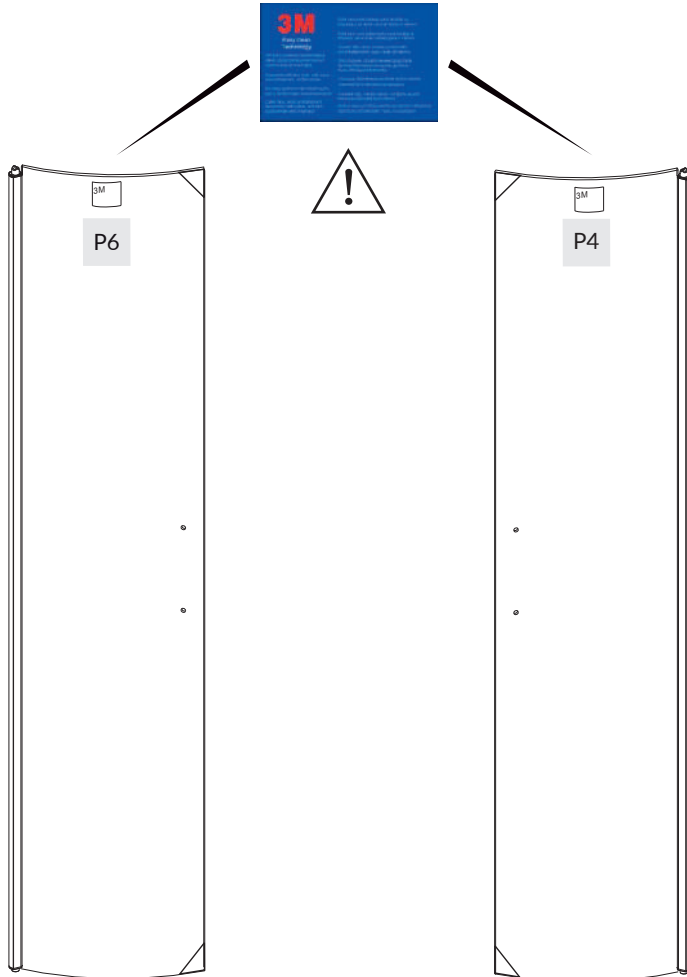

10.

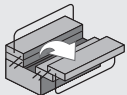
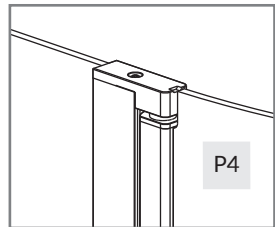
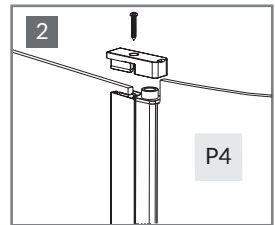
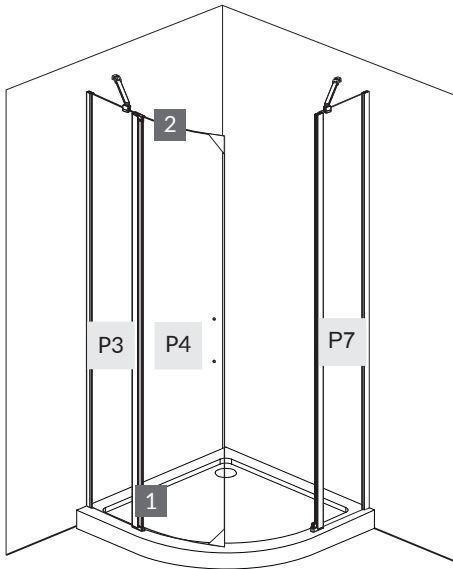
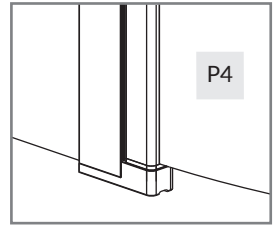
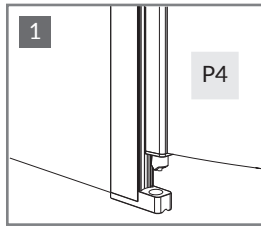
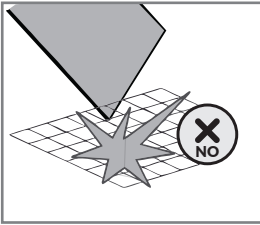

C

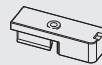

x1

E



x1



11.

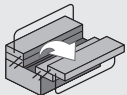
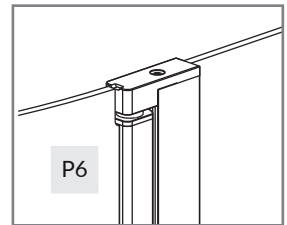
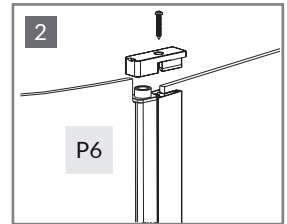
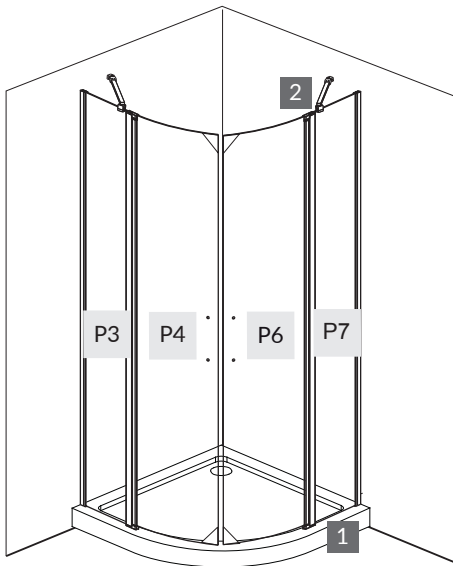
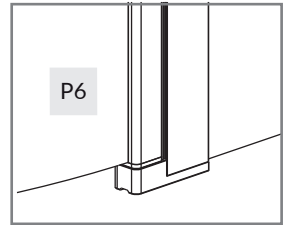
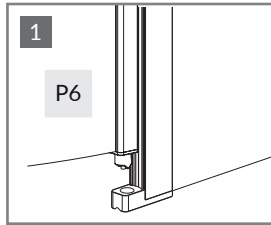
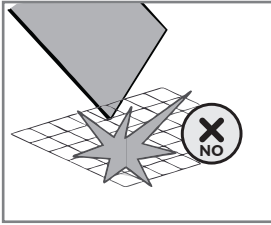

C



x1

E



x1



12.

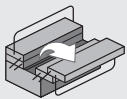
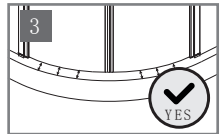
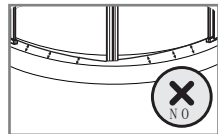
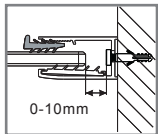
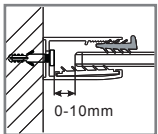
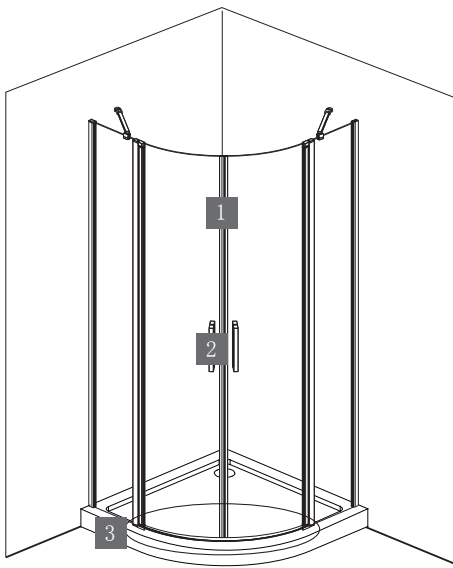
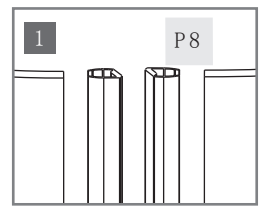
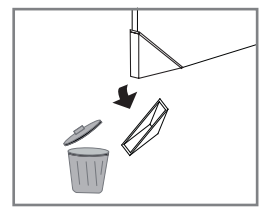
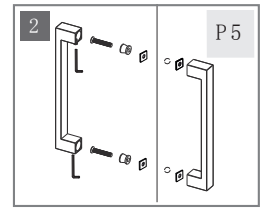
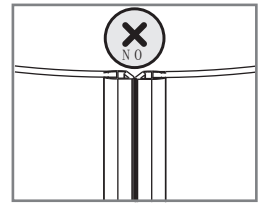
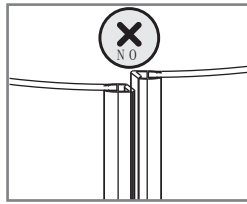
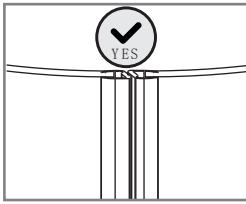

P8 ————— x2

P5 ————— x2



13.

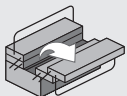
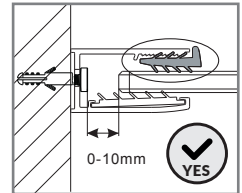
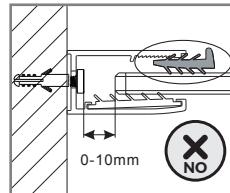
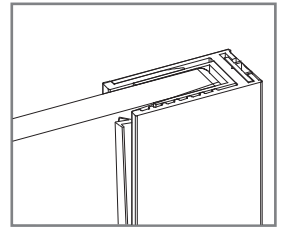
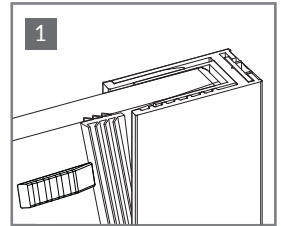
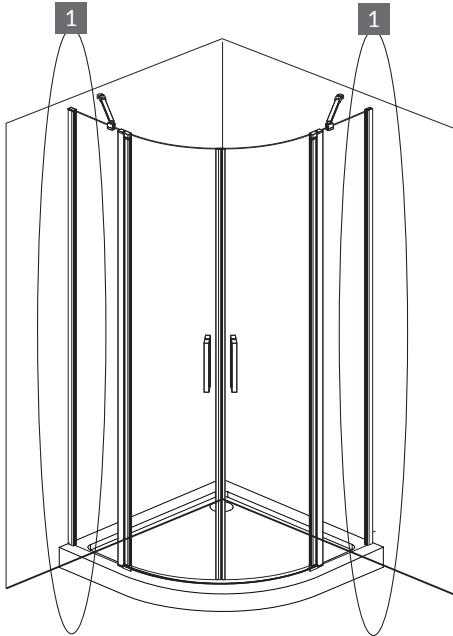
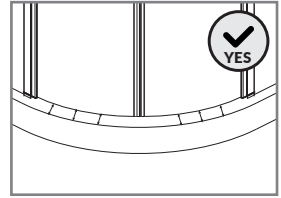
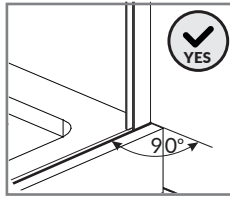
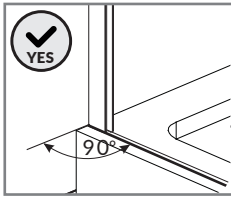

H



x1



14.

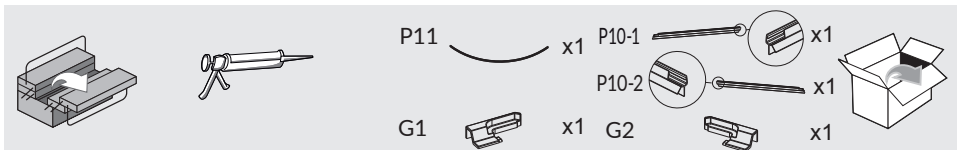
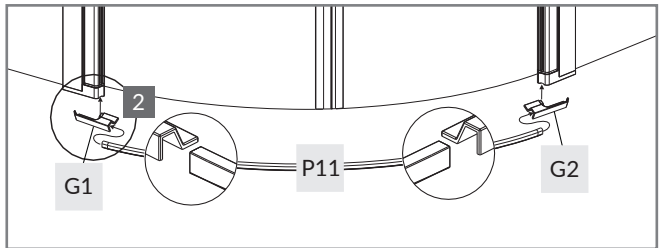
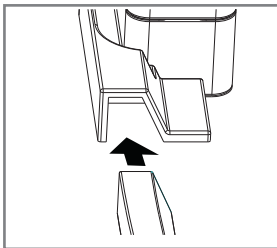
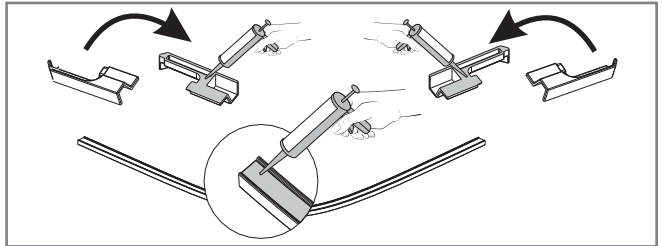
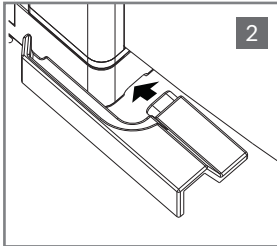
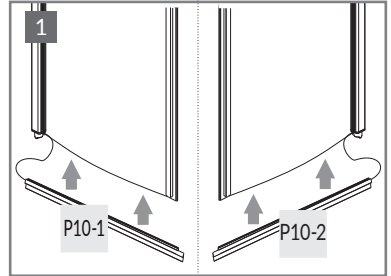
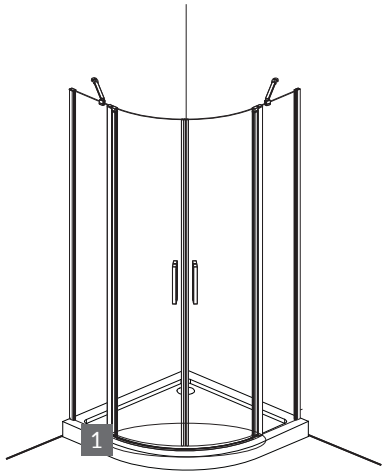

15.

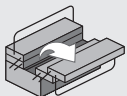
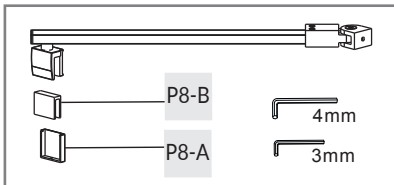
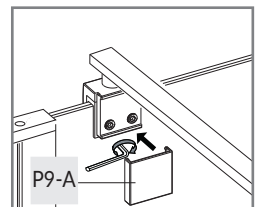
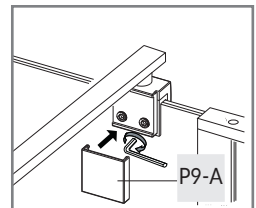
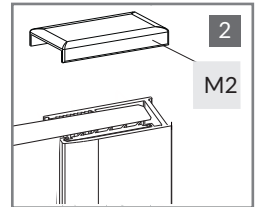
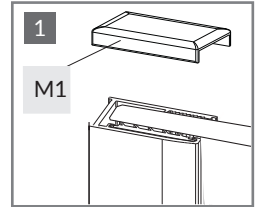
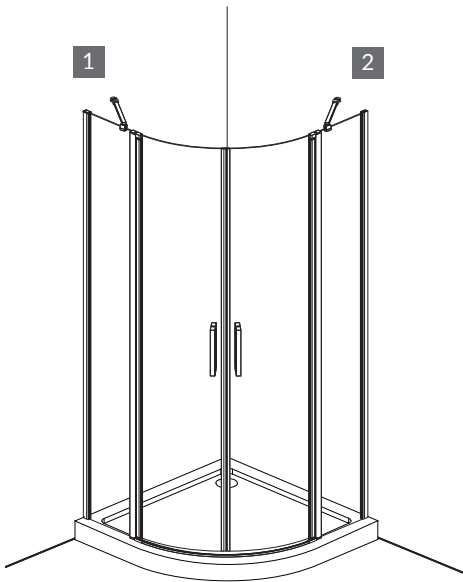
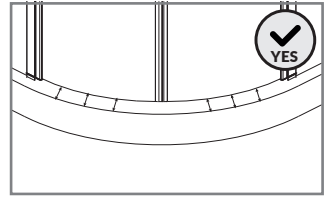
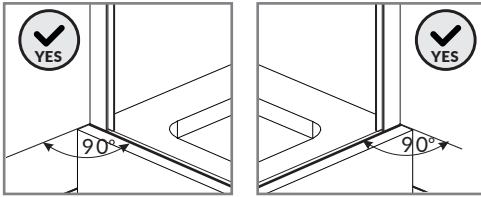

P9  x2

M1  x1

M2  x1



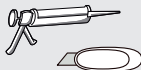
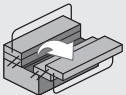
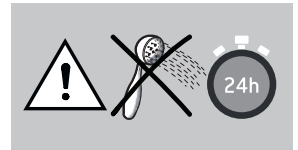
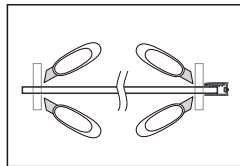
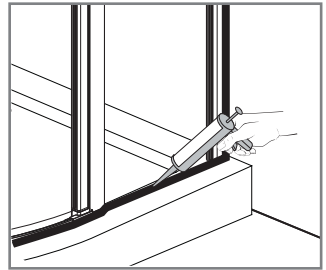
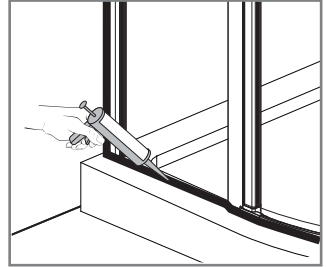
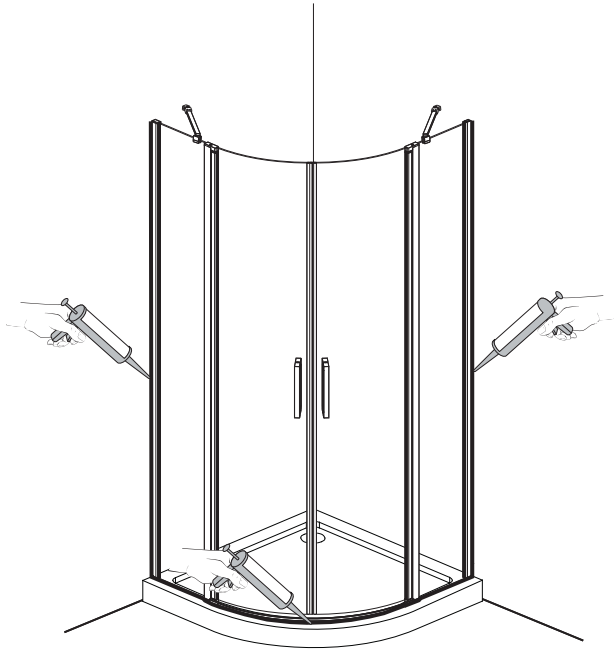



6.5 < PH < 7.5

