

ARTECO

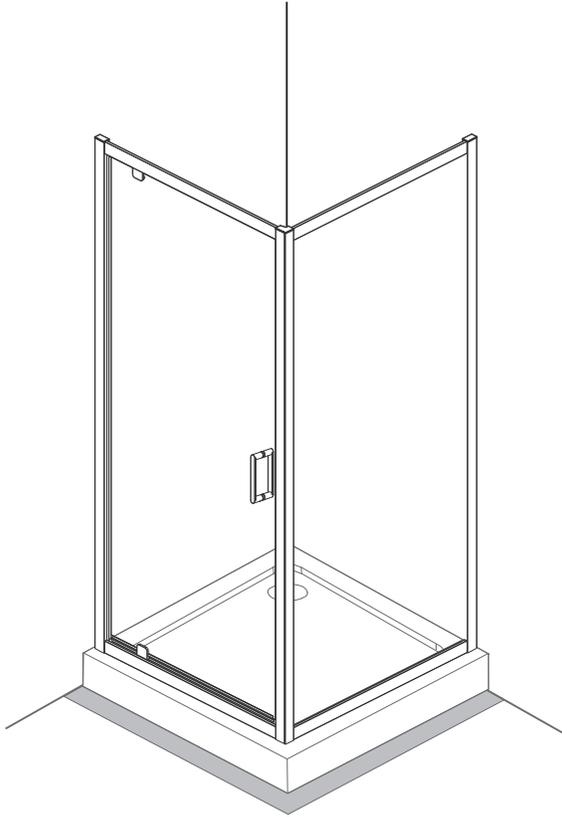

PL INSTRUKCJA MONTAŻU I EKSPLOATACJI

CZ NÁVOD NA MONTÁŽ A ÚDRŽBU

SK NÁVOD NA MONTÁŽ A ÚDRŽBU

EST PAIGALDUS- JA KASUTUSJUHEND

LT MONTAVIMO IR EKSPLOATAVIMO INSTRUKCIJA

LV MONTĀŽAS UN EKSPLUATĀCIJAS INSTRUKCIJA

DE MONTAGE- UND AUFBAUANLEITUNG

RO INSTRUCȚIUNI DE MONTAJ ȘI OPERARE

HU SZERELÉSI ÉS ÜZEMELTETÉSI ÚTMUTATÓ

UA ІНСТРУКЦІЯ З МОНТАЖУ І ЕКСПЛУАТАЦІЇ

BY ІНСТРУКЦЫЯ ПА МАНТАЖЫ І ЭКСПЛУАТАЦЫИ

RU ИНСТРУКЦИЯ ПО МОНТАЖУ И ЭКСПЛУАТАЦИИ

EN INSTRUCTIONS FOR ASSEMBLY AND USE

FR INSTALLATION ET UTILISATION - MODE

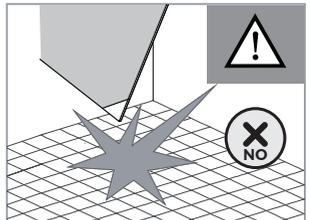
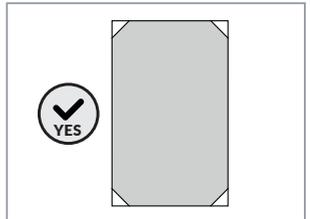
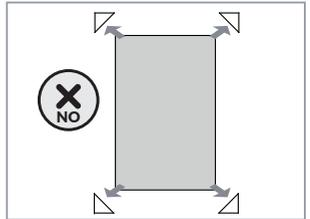
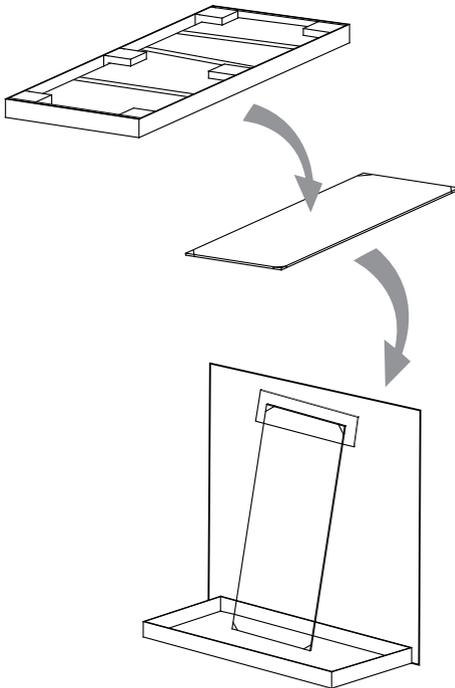
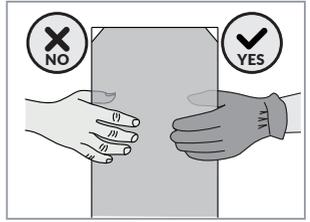
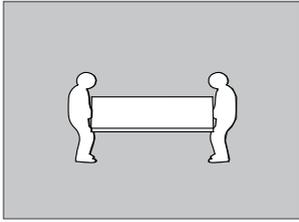
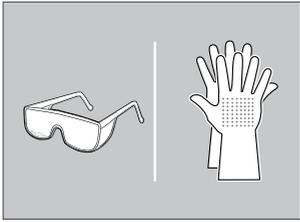
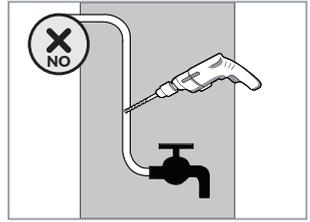
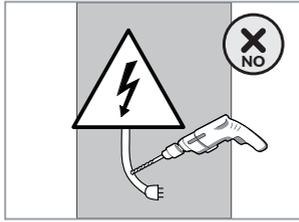
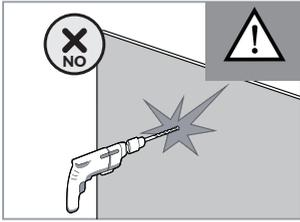

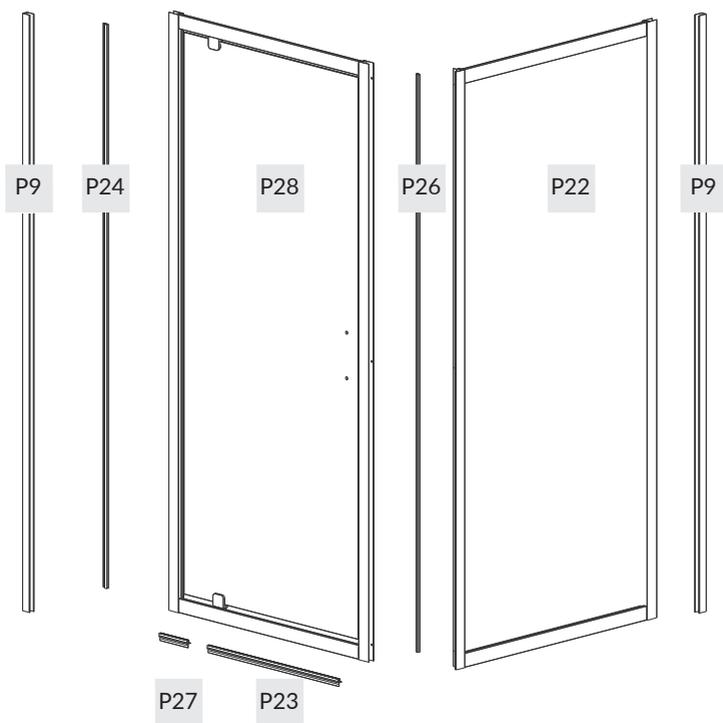



H1



x8

H2



ST4x45mm

x8

H3



ST4x9.5mm

x9

H8



x2

H9



x1

H10



x1

H13



x1

H14



x9

H15



x9

H22



x1

H23



x1

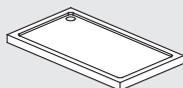
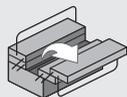

PH2

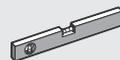
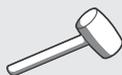

Ø 6mm



Ø 3mm

1.

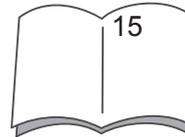
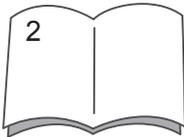
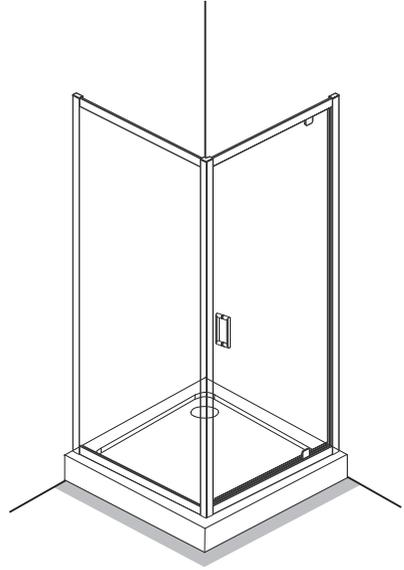
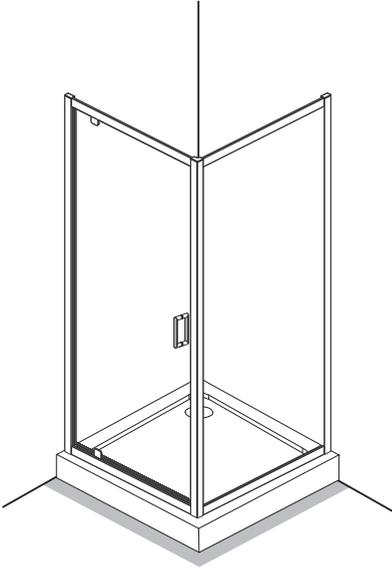

2.

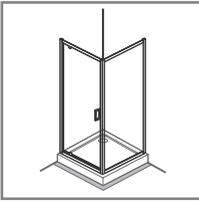

SIZE	X(mm)	Y(mm)
800x800x1900	783-798	783-798
900x900x1900	883-898	883-898

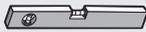
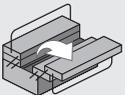
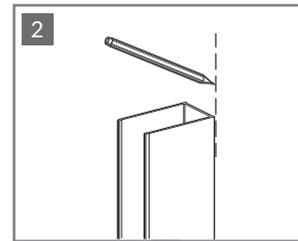
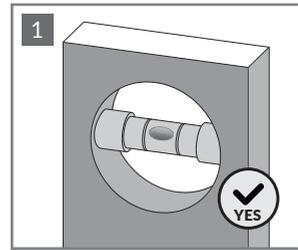
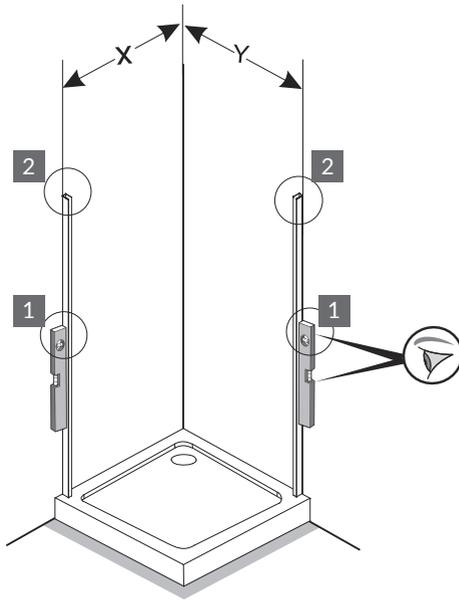

P9  x2



3.

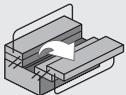
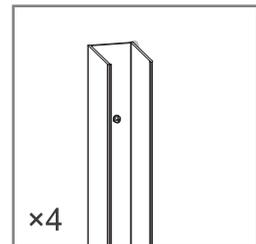
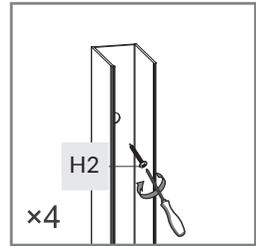
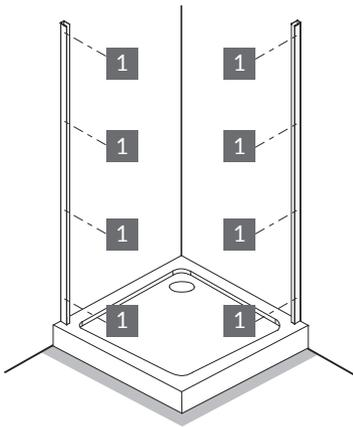
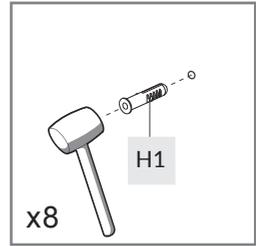
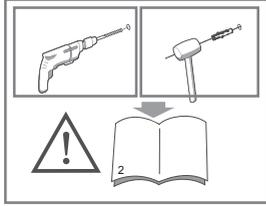
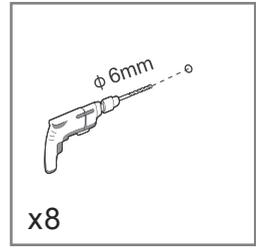
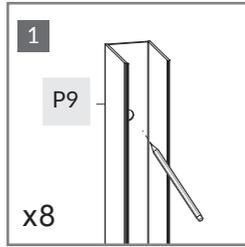
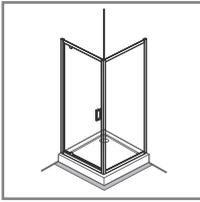

H1



x8

H2



x8

P9



x2



4.

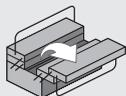
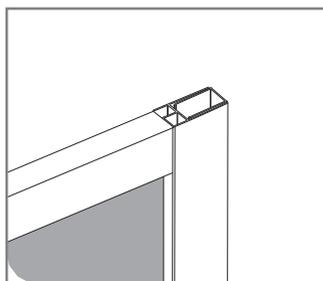
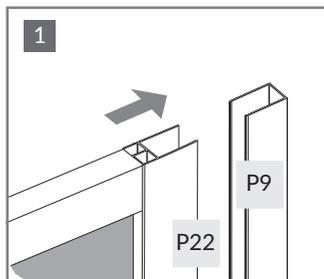
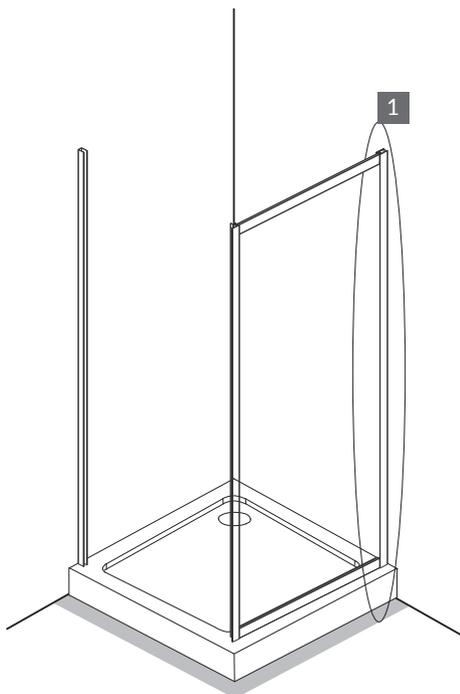
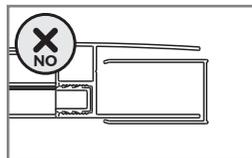
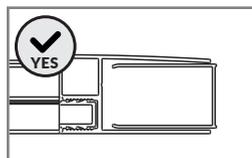
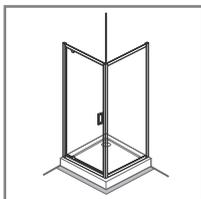

P22



x1

P9



x1



5.

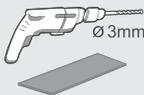
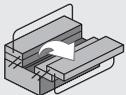
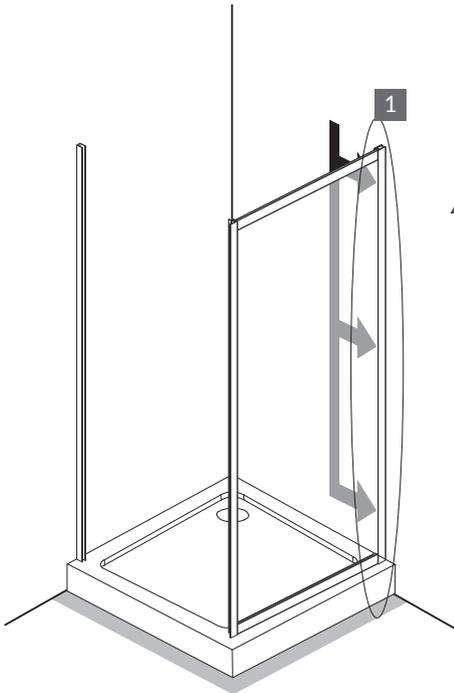
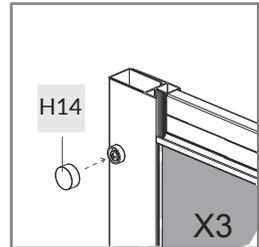
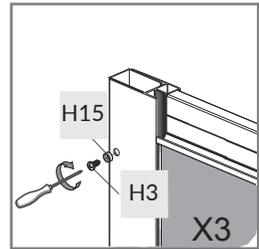
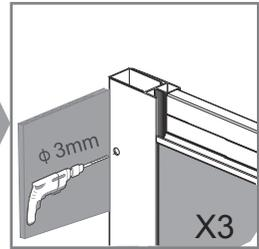
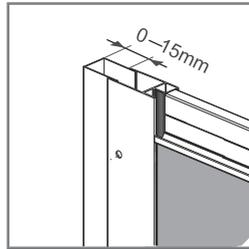
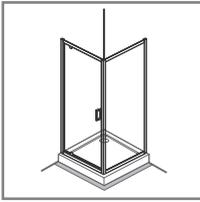

H3 x3

H14 x3

H15 x3



6.

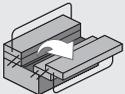
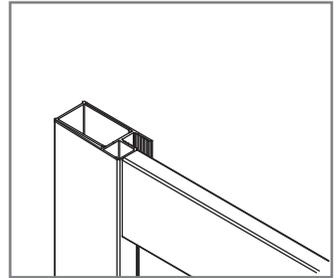
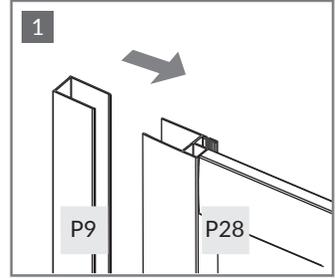
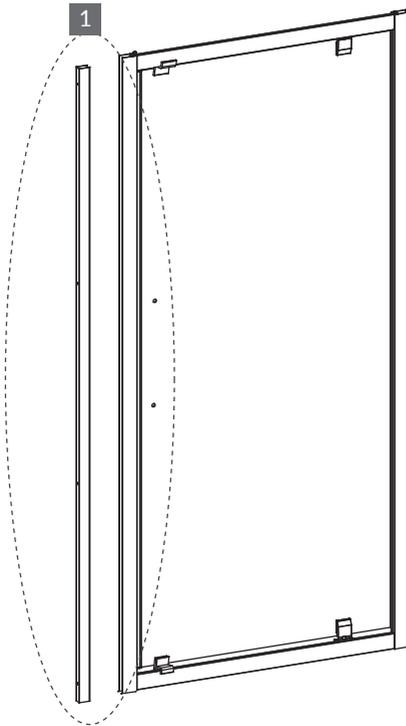
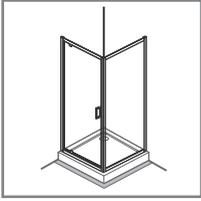

P28



x1

P9



x1



7.

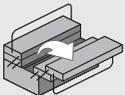
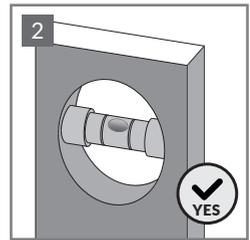
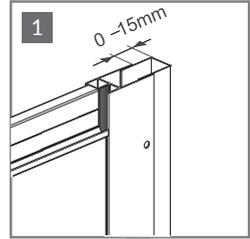
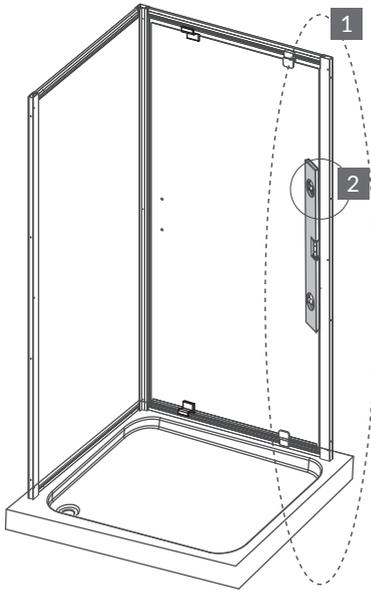
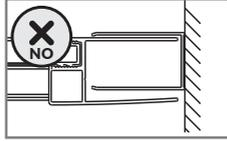
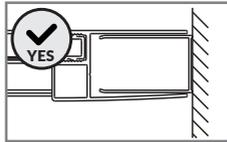
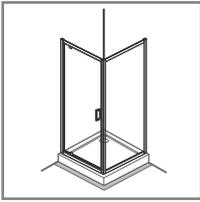

8.

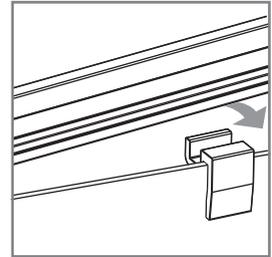
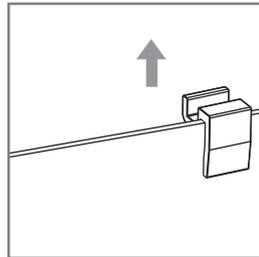
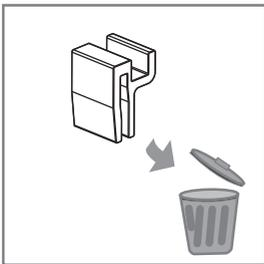
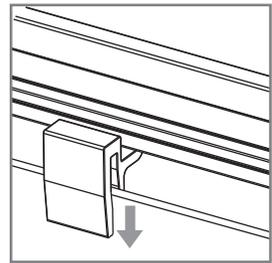
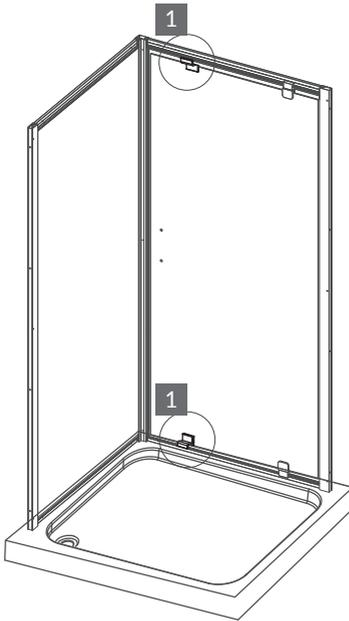
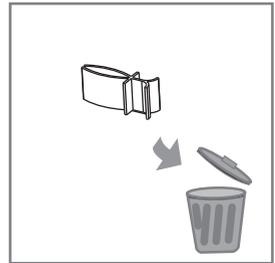
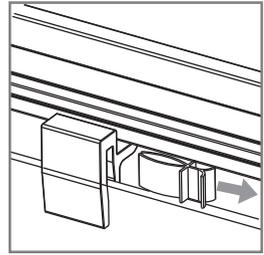
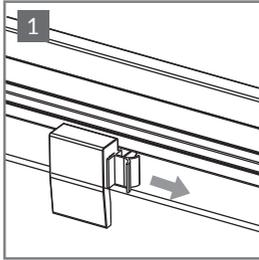
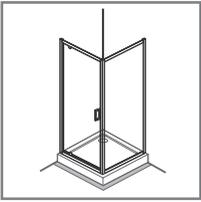

9.

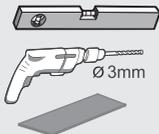
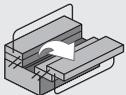
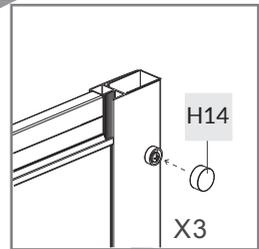
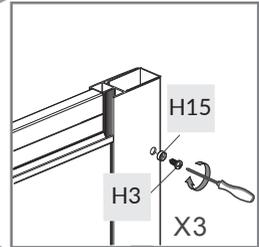
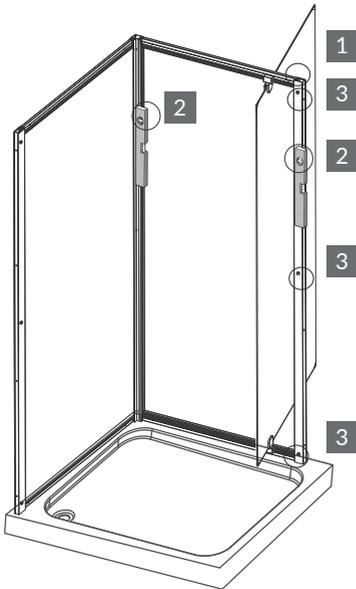
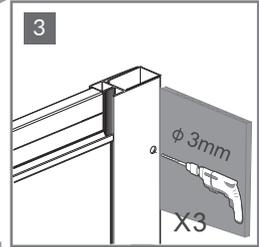
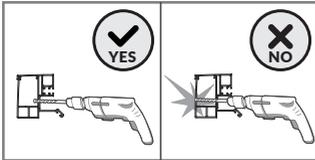
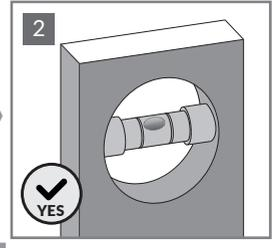
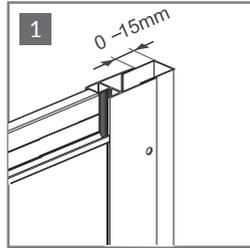
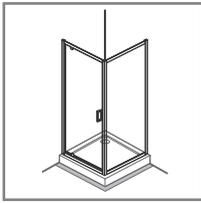

- H3  x3
- H14  x3
- H15  x3



10.

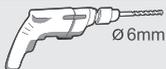
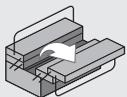
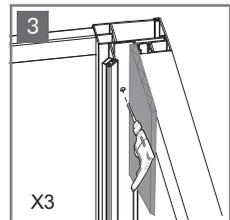
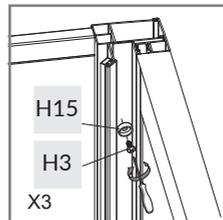
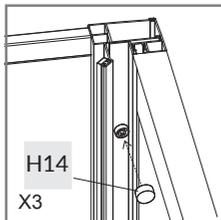
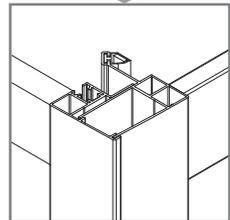
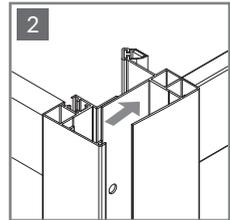
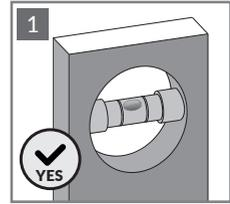
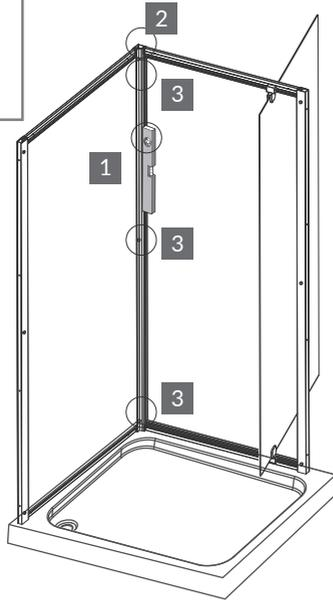
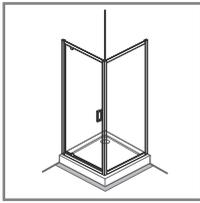

H3  X3

H14  X3

H15  X3



11.

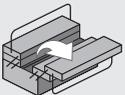
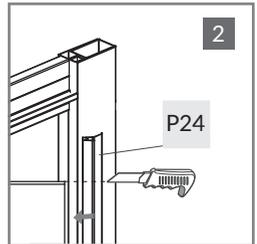
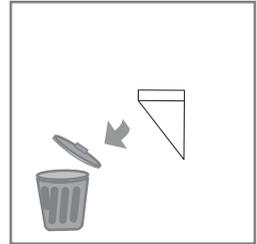
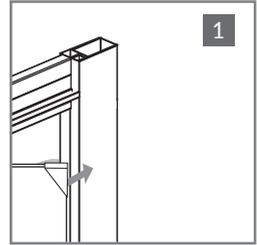
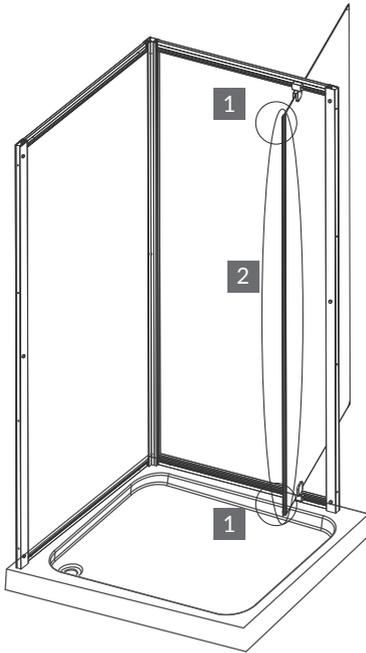
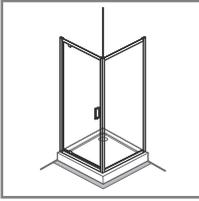

P24



x1



12.

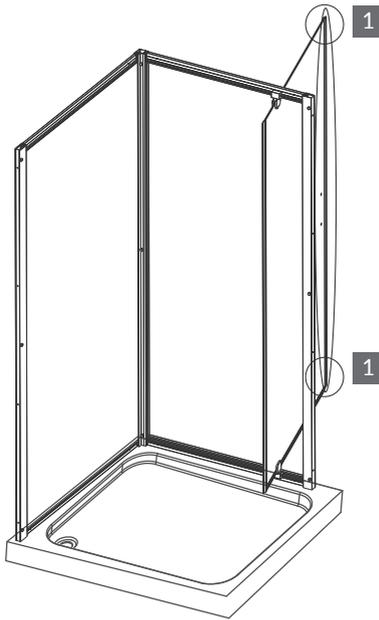
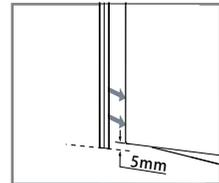
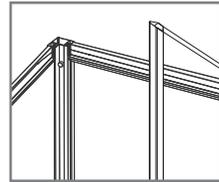
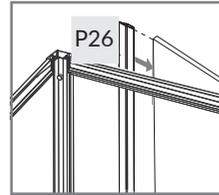
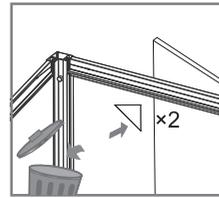
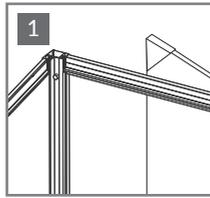
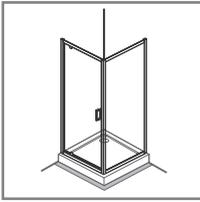

P26



x1



13.

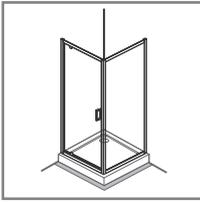

1

SIZE	L
700X1900mm	≈421mm
800X1900mm	≈521mm
900X1900mm	≈571mm

P23

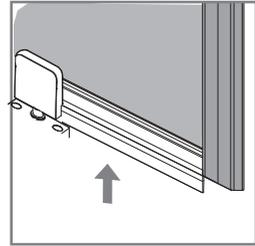

2

SIZE	L1
700X1900mm	≈73mm
800X1900mm	≈73mm
900X1900mm	≈123mm

P27

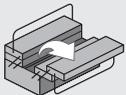
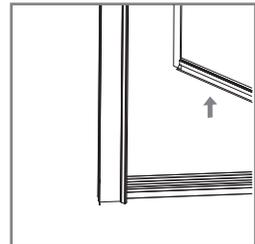

P23  x1

P27  x1



14.

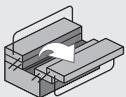
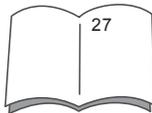
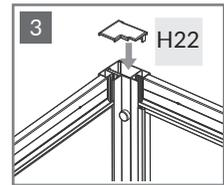
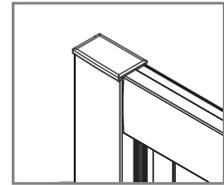
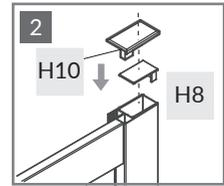
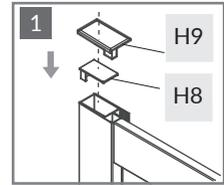
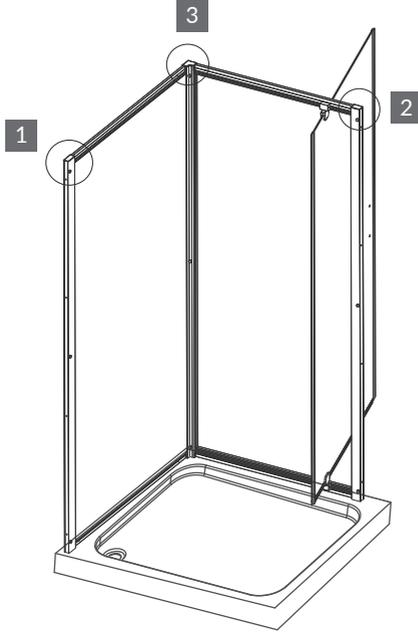
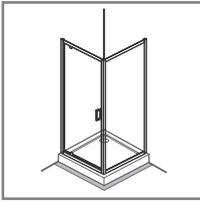

H8 x2

H9 x1

H10 x1

H22 x1



15.

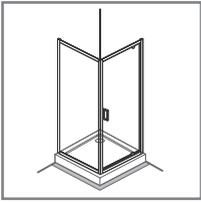

SIZE	X(mm)	Y(mm)
800x800x1900	783-798	783-798
900x900x1900	883-898	883-898

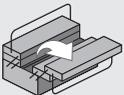
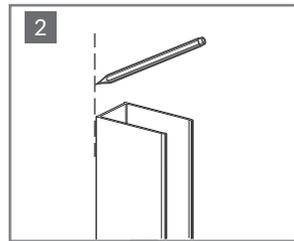
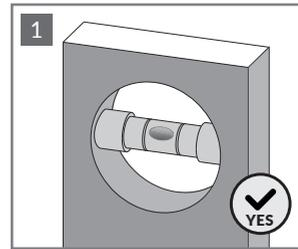
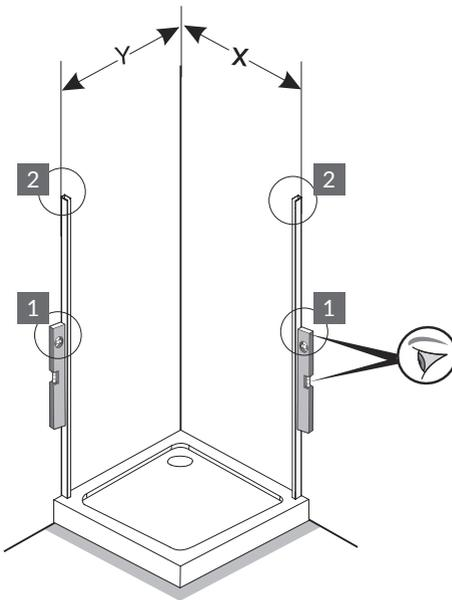

P9 x2



16.

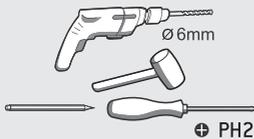
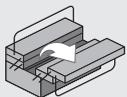
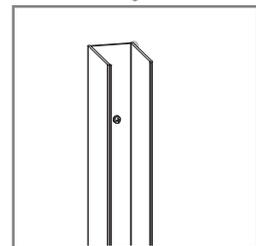
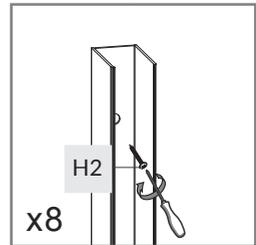
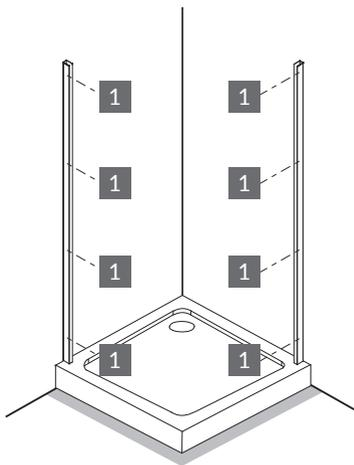
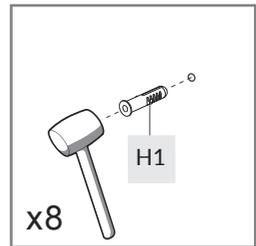
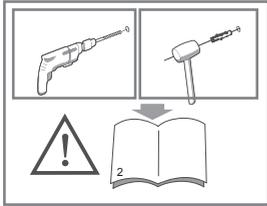
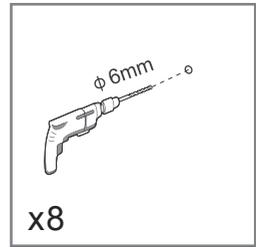
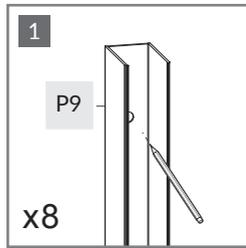
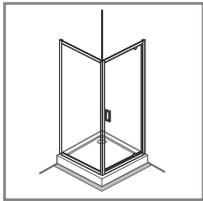

- H1  x8
- H2  x8
- P9  x2



17.

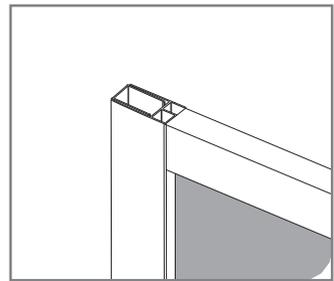
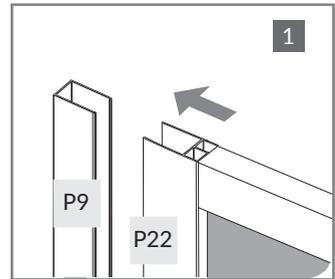
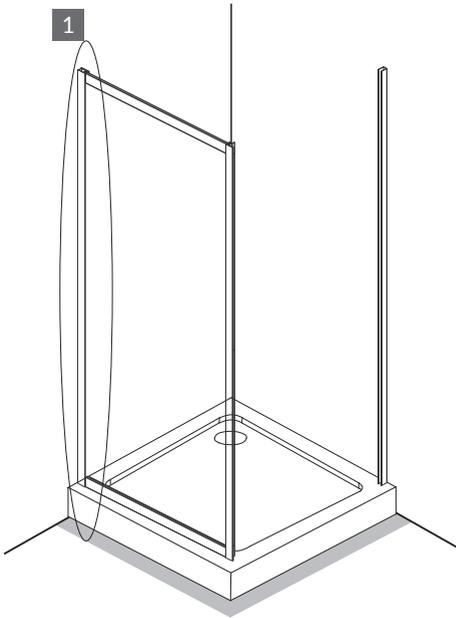
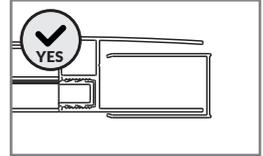
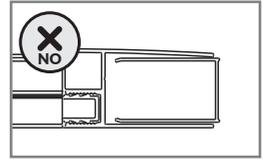
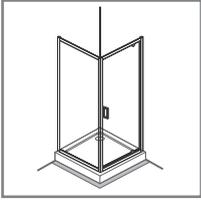

P22

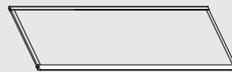

x1

P9



x1



18.

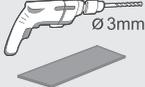
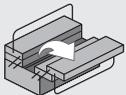
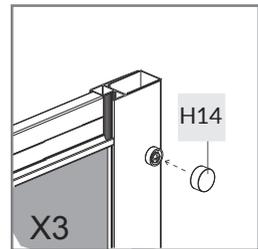
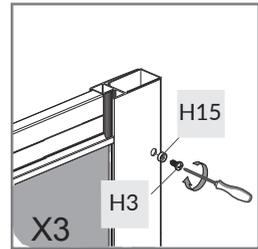
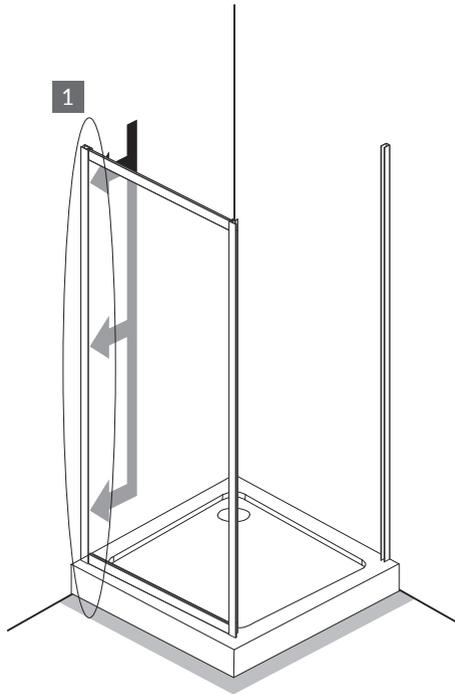
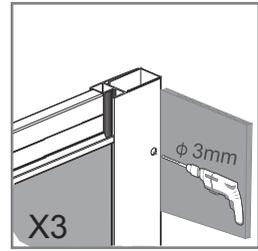
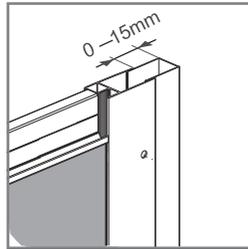
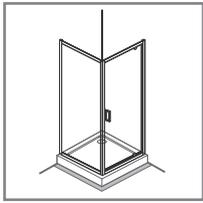

H3 x3

H14 x3

H15 x3



19.

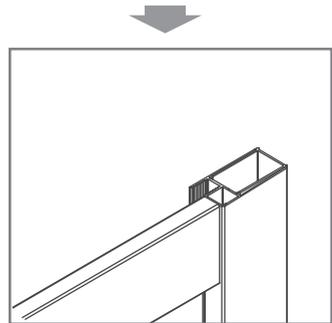
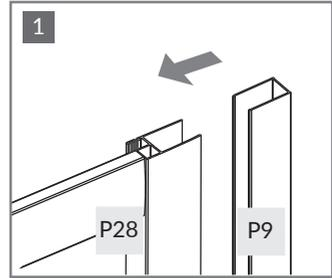
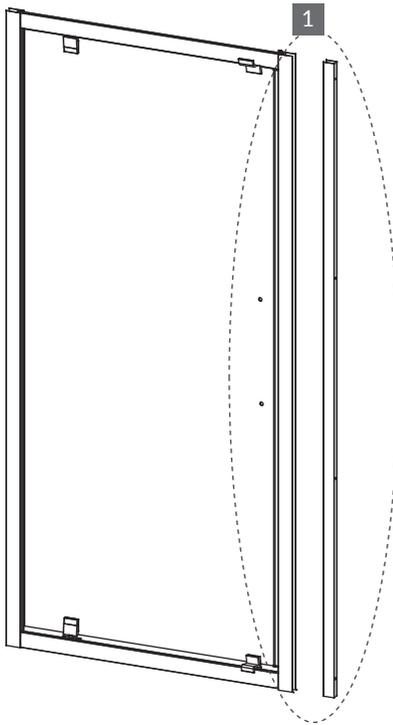
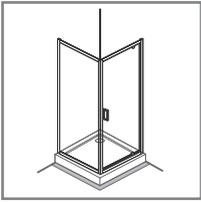

P28



x1

P9



x1



20.

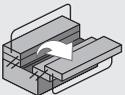
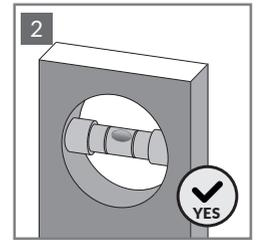
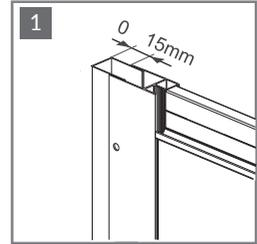
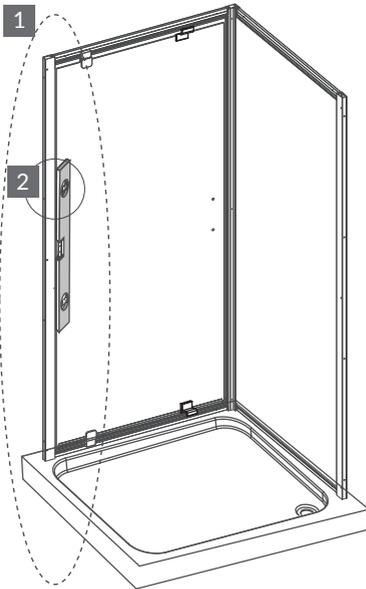
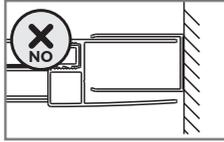
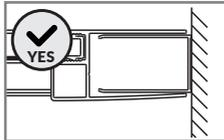
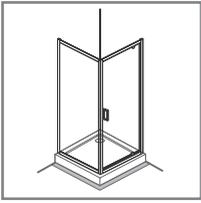

21.

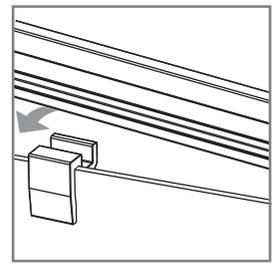
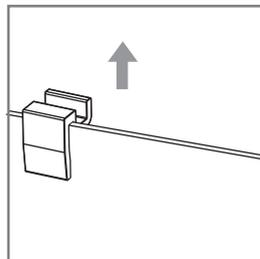
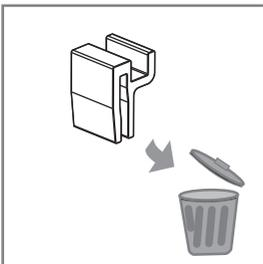
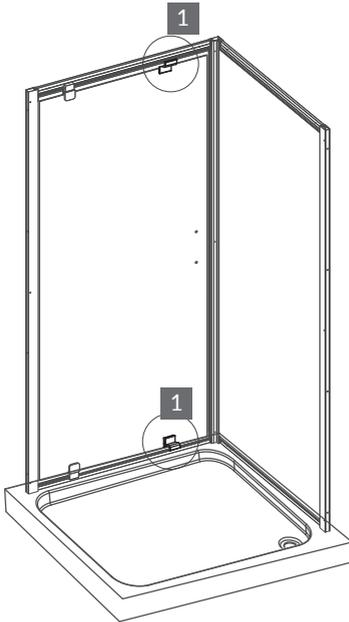
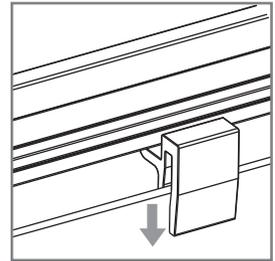
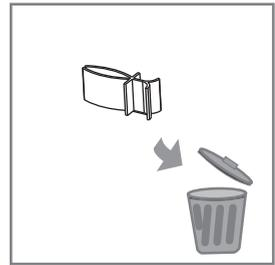
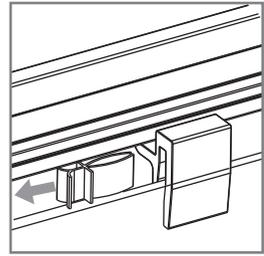
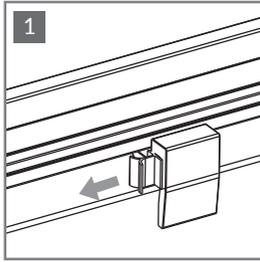
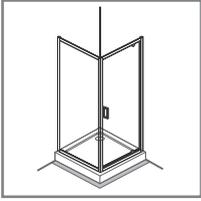

22.

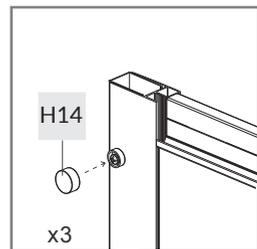
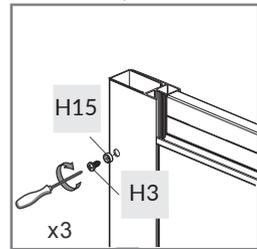
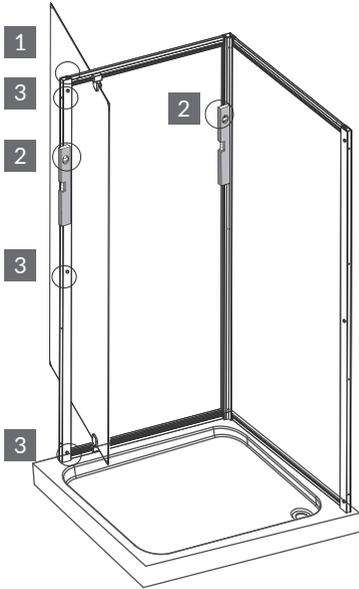
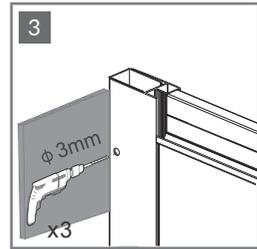
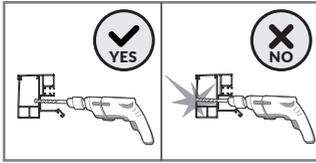
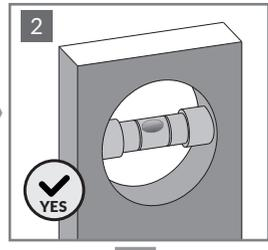
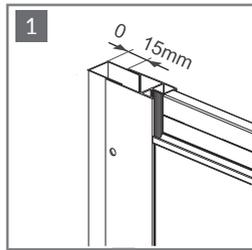
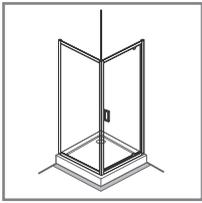

			H3		x3	
		H14		x3		
	H15		x3			

23.

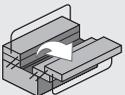
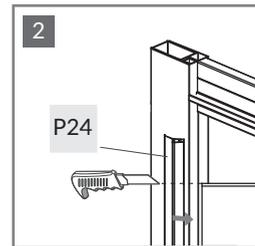
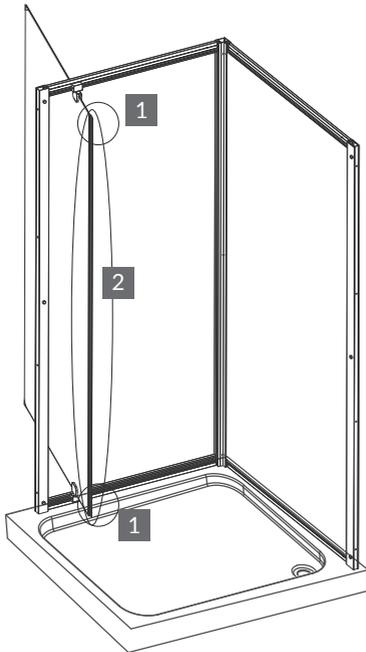
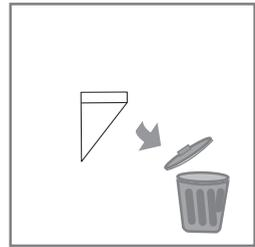
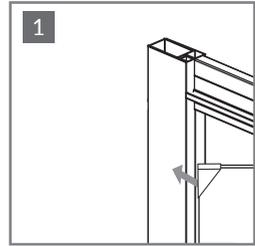
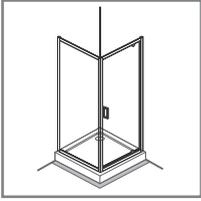

P24



x1



24.

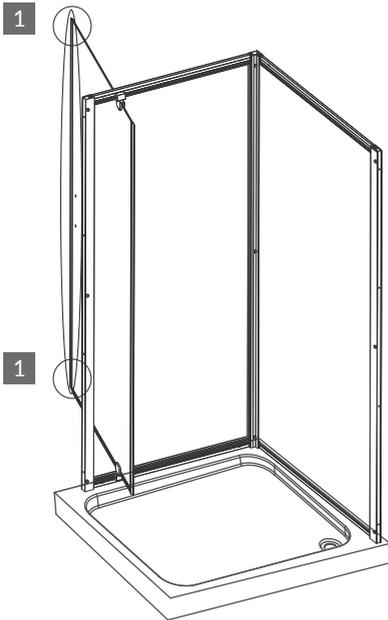
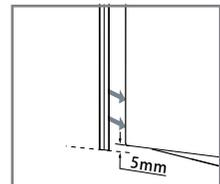
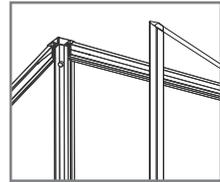
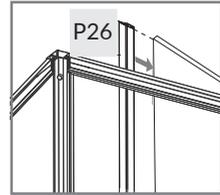
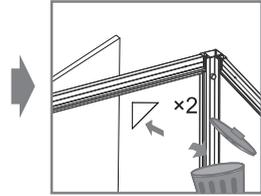
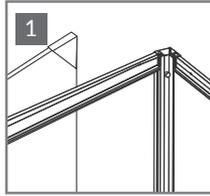
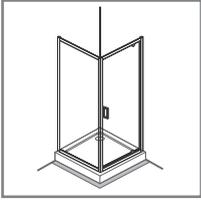

P26



x1



25.

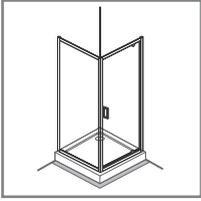

1

SIZE	L
700X1900mm	≈421mm
800X1900mm	≈521mm
900X1900mm	≈671mm

P23

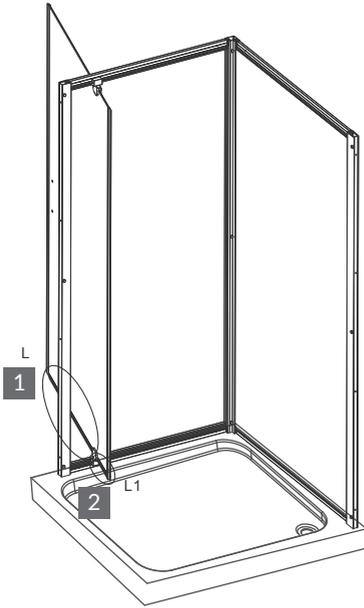
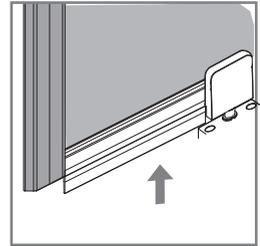

2

SIZE	L 1
700X1900mm	≈ 73mm
800X1900mm	≈ 73mm
900X1900mm	≈ 123mm

P27

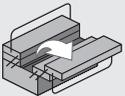
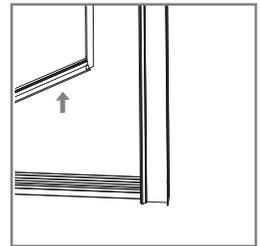

P23  x1

P27  x1



26.

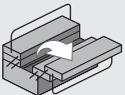
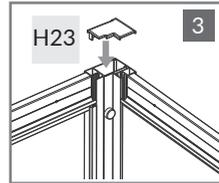
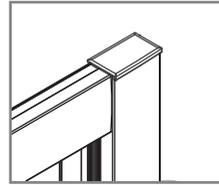
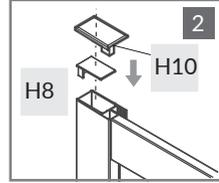
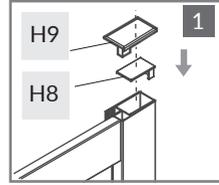
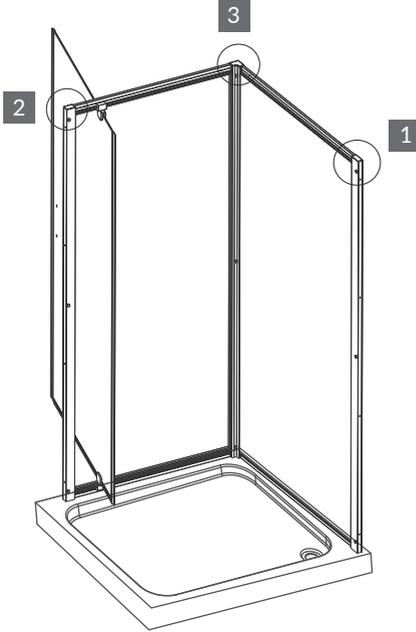
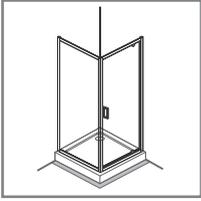

H8 x2

H9 x1

H10 x1

H23 x1



27.

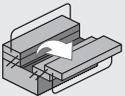
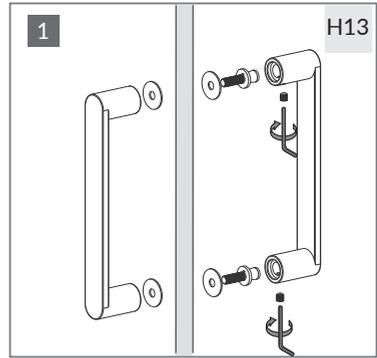
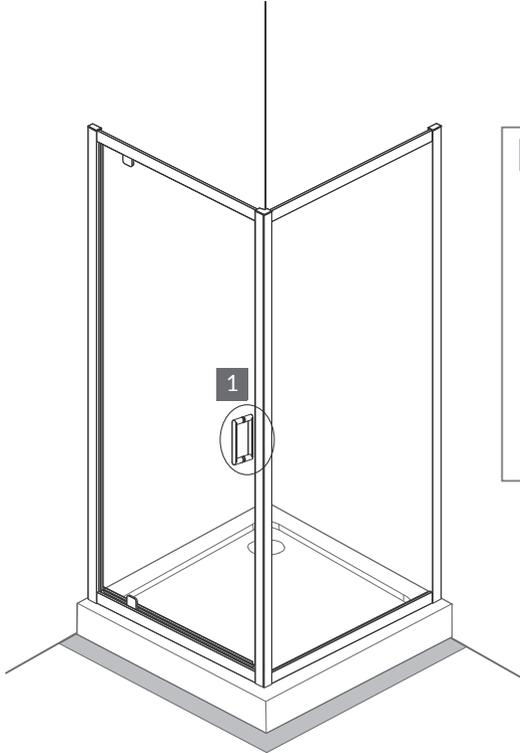
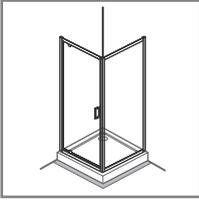

H13



x1



28.

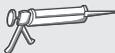
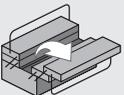
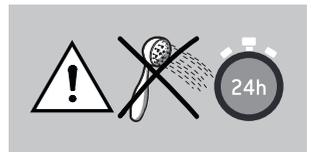
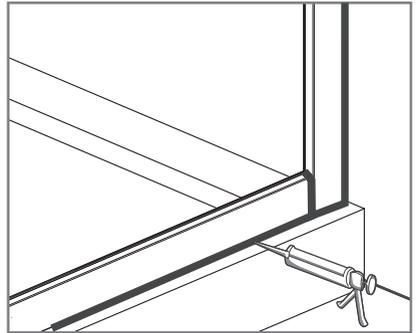
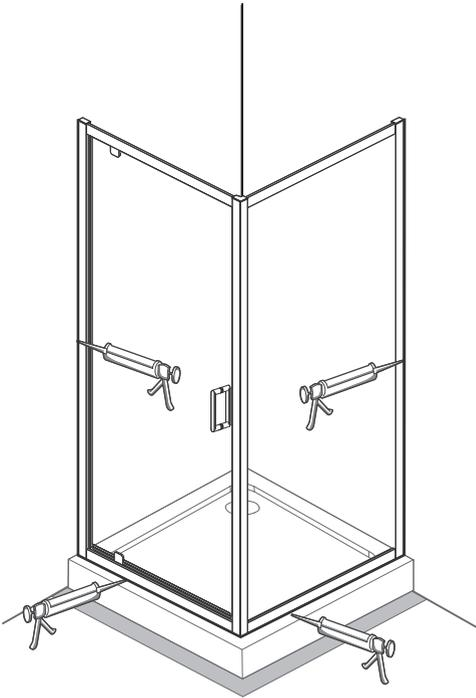
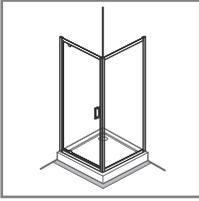



6.5 < PH < 7.5

