

600659V/600082V

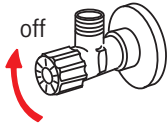

6150F, 6120F

1



4

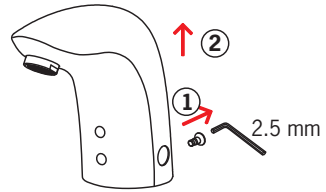

2

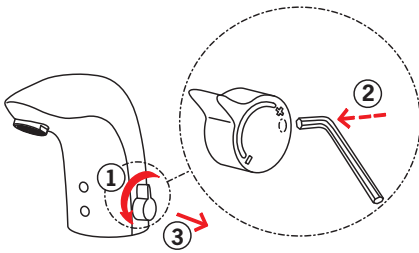

5

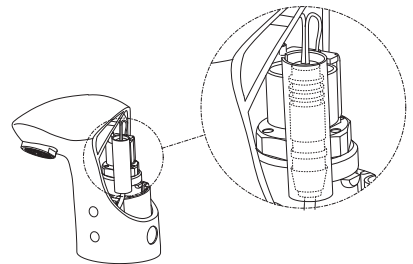

3

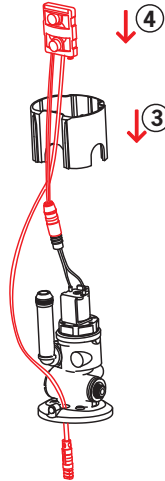
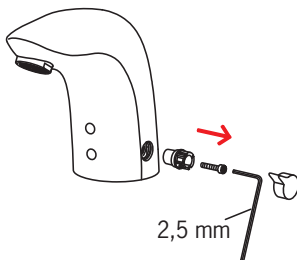

ORAS GROUP
Isometsäntie 2
P.O. Box 40
FI-26101 Rauma
Finland
Tel. +358 2 83 161
Fax +358 2 831 6300
Info.Finland@oras.com



945996/04/15

www.oras.com

CE (EMC 89/336/EEC)

600659V/600657V



2814F, 2816F

1

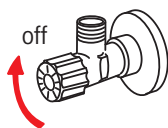

2

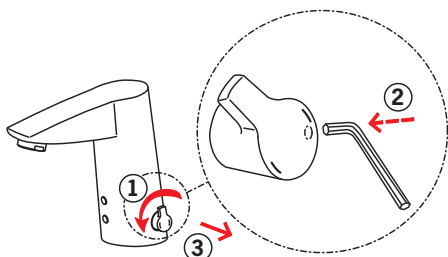

3

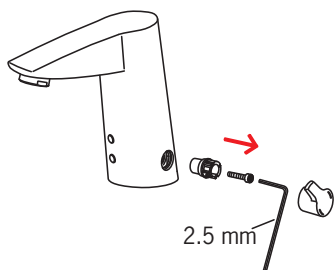

4

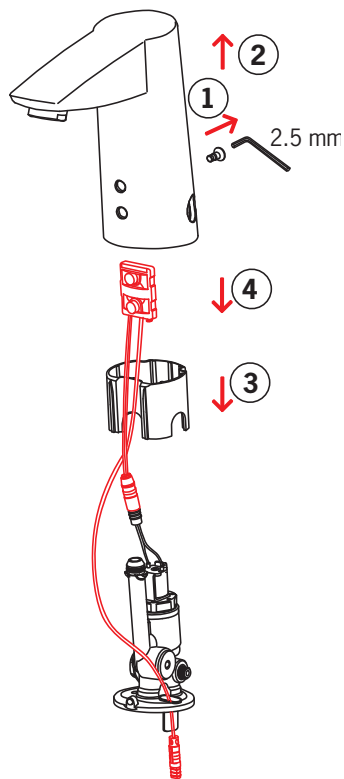

600659V/600657V



8514F, 8516F

1

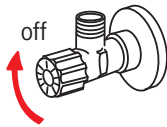

2

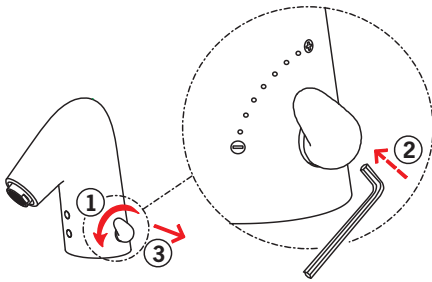

3

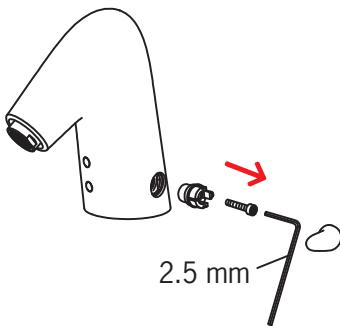

4

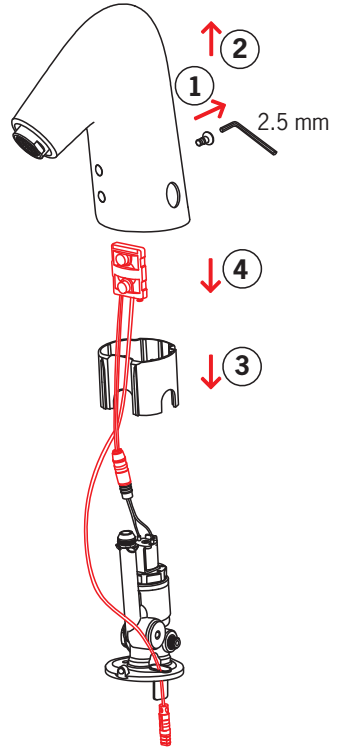

600766V, 600082V, 600656V, 600620V



6250F, 6222F, 6420G, 6422G, 6424G

1

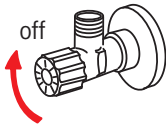

2

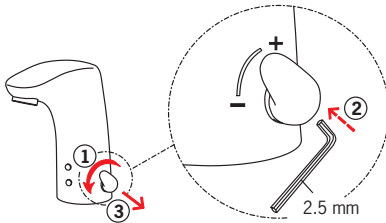

3

6222F, 6420G, 6422G,
6424G (01/2011-)

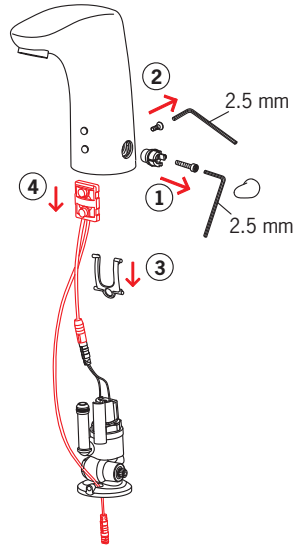

3

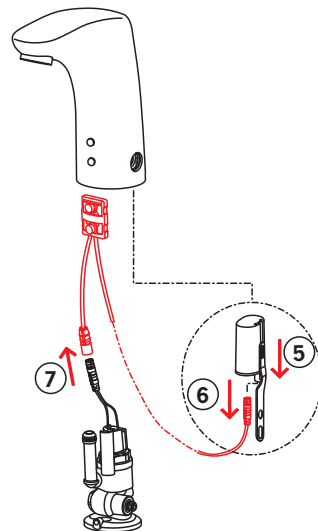
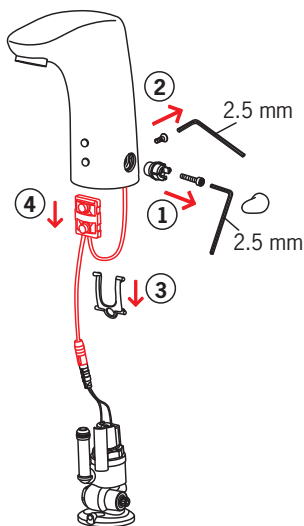

600656V, 600620V, 600452V, 198685V



6420G, 6422G,
6424G (-12/2010)

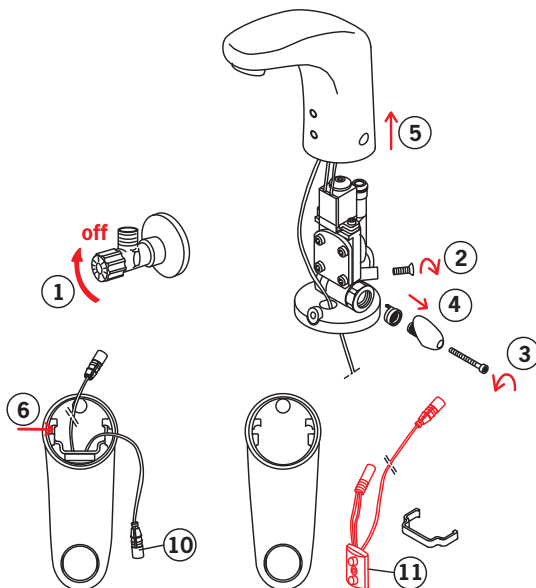

6250F/G (-12/2010)

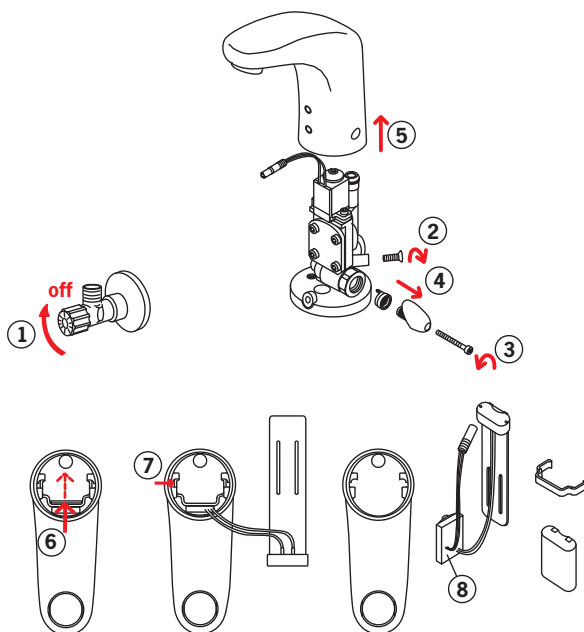

600774V, 600832V, 600780V, 600836V



6330F, 6331F, 6332F, 6333F, 6334F, 6335F, 6336F, 6337F

